

# DUTYPOINT **SETTING THE BAR**

## ScubaTANK WX



## Operation and Maintenance Manual

DOC-WXOM1802

# DUTYPOINT

SETTING  
THE BAR

## About us.

Applied knowledge.  
Shared know-how.  
Fearless innovation.

Together, we are Dutypoint. Since 1976, we've been building up industry-defining expertise in fluid technology.

This knowledge means we solve complex challenges with straightforward solutions that are built around meeting and exceeding our clients' needs. We approach everything with the same philosophy: how will we go above and beyond?

Our commitment to collaboration and sharing knowledge galvanises and cements robust relationships. Relationships that are built to last, because our clients are our partners.

Our focus for the future? Innovation. We want to be the future of our industry, globally. Where we benchmark thought leadership, expertise and customer care.

We set the bar.

## Contact details.

**T:** +44(0)1452 300592

**E:** [info@dutypoint.com](mailto:info@dutypoint.com)

**Registered Office:**

Dutypoint Limited  
Shepherd Road  
Gloucester  
GL2 5EL  
United Kingdom

# Table of Contents

Important Safety Information.....	4
Specifications.....	10
Installation Sequence.....	16
Commissioning.....	24
Operating the Pump Set.....	28
Pressure Vessel.....	30
System User Maintenance.....	34
Pump Maintenance.....	36
Pressure Set Point Adjustment.....	38
Frequently Asked Questions.....	40
Troubleshooting.....	42
Control Panel Wiring Diagrams.....	48
VASCO V209 and V214 Pump Controllers.....	50
EC Declaration of Conformity.....	68
Dutypoint Standard Warranty.....	70

© 2018 Dutypoint Limited

Dutypoint is a trading name of Dutypoint Limited, a company registered in England and Wales No 9045694

# 1. Important Safety Information

## 1.1 Health & Safety at Work Act 1974

Section 6(a) of this Act requires manufacturers to advise their customers on the safety and the handling precautions to be observed when installing, operating, maintaining and servicing their products. The user's attention is therefore drawn to the following:

- The appropriate sections of this manual must be read before working on the equipment.
- Installation, operating and maintenance must only be carried out by suitably trained/qualified personnel.
- Normal safety precautions must be taken and appropriate procedures observed to avoid accidents.

Refer to Dutypoint for any technical advice or product information. It is the responsibility of the customer and/or the contractor:

- To ensure that anyone working on the equipment is wearing all necessary protective gear/clothing;
- Is aware of appropriate health & safety warnings and to read the information in this manual.

## 1.2 Safety Messages and Hazard Statement

**Table 1.1:** Hazard Notice Definitions

Message Level	Definition
DANGER	A hazardous situation which, if not avoided, will result in death or serious injury
WARNING	A hazardous situation which, if not avoided, could result in death or serious injury
CAUTION	A hazardous situation which, if not avoided, could result in minor injury or moderate injury
ELECTRICAL HAZARD	Risks associated with electricity will cause hazards if not properly avoided
Note	A situation which may arise resulting in undesirable conditions and/or will not cause direct hazards to persons

## 1.3 Qualified Personnel

### WARNING

**This product is intended for operation by qualified personnel only**

- Only qualified personnel are allowed to install or operate this equipment
- Qualified personnel are defined as trained staff, who are authorised to install, commission and maintain equipment, systems and circuits in accordance with relevant laws and regulations. Personnel must be familiar with the instructions and safety procedures described in this document.
- This product should not be used by anyone with mental disabilities, or anyone without the relevant experience and knowledge, unless they have received instructions on using the equipment and on the associated risks, or are supervised by a responsible person.
- Children must be supervised to ensure they do not play on or around the equipment.

## 1.4 Environmental Protection

All local regulations and codes regarding emissions and waste disposal must be followed. This may include:

- Reporting of emissions to appropriate authorities

- Sorting, recycling and disposal of solid or liquid waste
- Clean-up of spills
- Separate disposal of electrical components from domestic waste

## 1.5 Mechanical Device Servicing

- Familiarise yourself with the relevant contents of this manual
- Installation, maintenance and repair work must only be carried out by trained, skilled and suitably qualified personnel.
- Disconnect or lock-out the power source to ensure that the item(s) will remain inoperative. Locking out the equipment by switching off the release mechanism or set value WILL NOT prevent accidental starting.
- Allow the item(s) to cool if over-heated.
- CLOSE the isolating valves on the suction and discharge connections of the affected item(s).
- If working on pump, VENT slowly and cautiously – Refer to the relevant section of this manual.
- DRAIN the pump(s).

## 1.6 Pump Hand Control Mode (Where Fitted)

In the 'HAND' position the pump(s) controlled by the switch will normally run at full speed and completely independently of any control devices, and can result in pump(s) running against a closed valve head if there is no draw. This can cause the system to be maintained at the maximum pressure produced by the pump plus any incoming pressure and additional pressure caused by water surge and can potentially damage the pump and other parts of the system.

The 'HAND' option should only be used with a competent operator in attendance, or when there is a continued demand sufficient to provide constant flow through the pumps to maintain the running pressure of the system to an acceptable level.

## 1.7 Personal Protective Equipment

Use personal safety equipment according to the site conditions and employer regulations. This may include, but may not be limited to:

- Hard hat
- Safety goggles with side shields
- Protective footwear
- Protective gloves
- Respirator
- Ear protection
- First aid kit
- Safety devices

## 1.8 Precautions Before Commencing Work

Ensure that the following safety precautions are complied with before commencing work:

- Provide a suitable barrier around the work area
- Ensure all safety guards are in place and secure
- Ensure you have a clear path of exit
- Ensure that the product cannot roll or fall over and cause damage to persons or property
- Ensure all lifting equipment is in good condition and rated for the intended task
- Use a lifting harness, safety line and respirator as required
- Allow hot components to cool before handling them
- Ensure that product has been thoroughly cleaned
- Disconnect and lock out power supply, ensuring that it cannot be accidentally re-connected

- Check for any risk of explosion before using hand tools

## 1.9 Precautions During Work

- Never work alone
- Always wear protective clothing and hand protection
- Stay clear of suspended loads
- Always use appropriate lifting devices
- Beware of risks of sudden starts of any automated equipment such as level control
- Beware of starting jerks of electric motors - these can be powerful
- Do not exceed the stated operating limits of equipment
- Do not remove vent plugs from a pressurised system - ensure pressurised components are relieved of pressure before disassembly
- Ensure guards are in place during operation

## 1.10 Hazardous Fluids and Chemicals

If hazardous chemicals come into contact with skin or eyes, use the following procedures:

Condition	Action
Chemicals or hazardous fluids in eyes	<ol style="list-style-type: none"> <li>1) Hold your eyelids apart forcibly with your fingers</li> <li>2) Rinse the eyes with eyewash or running water for at least 15 minutes</li> <li>3) Seek medical attention</li> </ol>
Chemicals or hazardous fluids on skin	<ol style="list-style-type: none"> <li>1) Remove contaminated clothing</li> <li>2) Wash the skin with soap and water for at least 1 minute</li> <li>3) Seek medical attention</li> </ol>

## 1.11 Electrical Safety - High Voltages

This information is especially applicable when Variable Speed Controllers (Inverters) are fitted to pumps.

When the inverter variable speed drive head is connected to the power supply the components of the power unit as well as certain components of the master control unit – are also connected to the power supply.

### **DANGER!**

#### **Touching these components can seriously endanger life!**

- Before removing the frequency inverter cover, the system must be disconnected from the power supply
- After switching off the power supply wait at least 5 minutes before starting work on or in the inverter drive head - the capacitors in the intermediate circuit must be given time to discharge completely via the discharge restors.

### **ELECTRICAL HAZARD**

#### **Up to 800V can be present - if there are faults this can be higher**

- All work carried out when the frequency inverter is open must be performed only by suitably qualified and properly authorised personnel.

## ELECTRICAL HAZARD

**THE SYSTEM MUST ONLY BE OPERATED WHEN IT HAS BEEN CORRECTLY EARTHED AND PIPES BONDED TO EARTH IN ACCORDANCE WITH IEE REGULATIONS**

- When connecting external control wires care must be taken not to short circuit adjacent components. Bare cable ends which are not in use must be insulated.
- 

### 1.12 Electronic Safety Devices

- Inverter drives contain electronic safety devices which switch off the control element in the event of a fault developing.
  - A motor can also be stopped by 'mechanical blocking'
  - If it is switched off electronically, the motor is disconnected from the mains voltage supply via the electronics in the inverter drive.
  - Voltage fluctuation and power failures (temporary outages) can cause the motor to switch itself off.
- 

#### WARNING

**A motor will have zero current but will remain energised as it stops**

- Take necessary precautions - the motor is not voltage-free in the circuit itself
- 

#### WARNING

**Repair of faults can cause items to start up again unexpectedly**

- Ensure the motor is isolated before commencing any work
- 

#### WARNING

**High voltage tests of inverters may damage the electrical components.**

- Bridge before the incoming/outgoing terminals L-L2-L3 and U-V-W.
  - To avoid incorrect metering by capacitors incorporated in the electronic circuits, isolate the motor from the inverter drive head.
- 

### 1.13 Spare Parts

#### WARNING

**Use of non-genuine spare parts may cause damage to equipment, damage to property and voiding of warranty**

- Use genuine, Dutypoint-approved spare parts only
  - If in doubt, contact Dutypoint Service on 01452 300590.
-

---

## 1.14 Transportation and Lifting

---

### WARNING: LIFTING HAZARDS

- Stay clear of suspended loads
  - Observe accident prevention regulations in force
  - Do not damage the cables during transports; so not squeeze, bend or dray the cable
  - Always keeps the cable ends dry
  - Secure the unit against tipping over and slipping until it is mounted and fixed in its final location
  - Lift and handle the product carefully, using suitable lifting equipment (stacker, crane, crane mounting device, lifting blocks, sling ropes, etc.)
  - Always lift the unit by its lifting handle
- 

### WARNING: ASSEMBLED SYSTEMS ARE HEAVY

- Failure to properly lift and support this equipment can result in serious physical injury and/or equipment damage,
  - Lift equipment only at the specifically identified lifting points.
  - Lifting devices such as eye bolts, slings and spreaders must be rated, selected and used for the entire load being lifted
  - Select the appropriate lifting points
- 

- 1) Inspect the package
  - a) Inspect the package for damage or missing items upon delivery
  - b) Note any damaged or missing items on the shipping paperwork and contact Dutypoint immediately
  - c) File a claim with the shipping company if anything is out of order
  - d) If the product has been picked up at a distributor, file a claim with the distributor
- 2) Inspect the unit
  - a) Remove packing materials from the product
  - b) Dispose of all packing materials in accordance with local regulations
  - c) Inspect the product to determine if any parts have been damaged or are missing
  - d) If applicable, unfasten the product by removing any screw, bolts or straps. For your personal safety, be careful when you handle nails and straps.
  - e) Contact Dutypoint if you have any issues.

## 1.15 Storage

The product must be stored in a covered and dry location free from heat, dirt and vibrations.

**NOTE:** Protect the product against humidity, heat sources and mechanical damage

**NOTE:** Do not place heavy weights on the packed product

**NOTE:** See section on storage limits

## 1.16 Disposal

At the end of its working life, this product should not be disposed of with standard household waste, but rather dropped off at a collection point for the disposal of Waste Electrical and Electronic Equipment (WEEE) for recycling.



**Figure 1.1:** Waste Symbol



This is confirmed by the *Waste Symbol* found on the product, user manual or packaging.

Depending on their characteristics the materials may be recycled. Through recycling and other forms of processing Waste Electrical and Electronic Equipment, you can make a significant contribution towards helping to protect the environment.

Please contact your local authorities for information on the collection point nearest you.

## 2. Specifications

**Table 2.2:** ScubaTANK WX Standard Range Specifications

Applications	Water with no gas or aggressive substances
Flow Range	0.8 - 3.1 litres/sec
Pressure Range	2.0 - 7.0 bar
Liquid Temperature	1°C - 23°C
Ambient Temperature	+5°C - +40°C for indoor installations
Humidity	Max 50%
Controller Type	Modus VASCO as standard - other types available
Protection	Low water level via probe control
Tank Construction	GRP construction 25mm insulation (HCFC and CFC free) Base reinforced with encapsulated multi-ply board and fitted with fixing brackets
Tank Capacity	175 - 2,250 litres
Inlet Valve	¾" or 1" high flow solenoid valve
Discharge	WX1 models: 1¼" BSP WX2 models: 1½" BSP
Pressure Vessel	12 litre stainless steel

### 2.1 Identifying ScubaTANK Models

**Figure 2.2:** ScubaTANK Model Codes

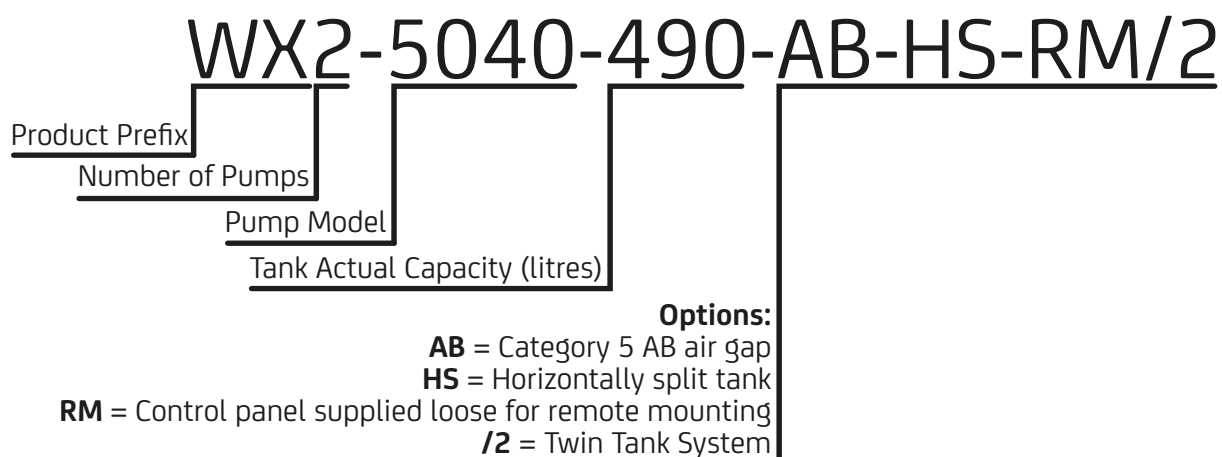

**Table 2.3: Pump Ratings**

Pump Model	Motor kW Rating	Power Supply to Control Panel (V/Ph/Hz)	Power Output from Inverter to Pump (V/Ph/Hz)	Full Load Current (A)
3040-T230	0.55	230/1/50	230/3/50	4.1
3040-T230	0.75			5.2
3080-T230	1.1			7.4
3100-T230	1.5			5.5
5040-T230	0.75			5.0
5060-T230	1.1			7.4
5080-T230	1.5			10.5
5100-T230	2.2			9.0
9040-T230	1.5			10.5
9060-T230	2.2			11.9
9070-T	3	400/3/50	400/3/50	5.9
9090-T	3			6.8

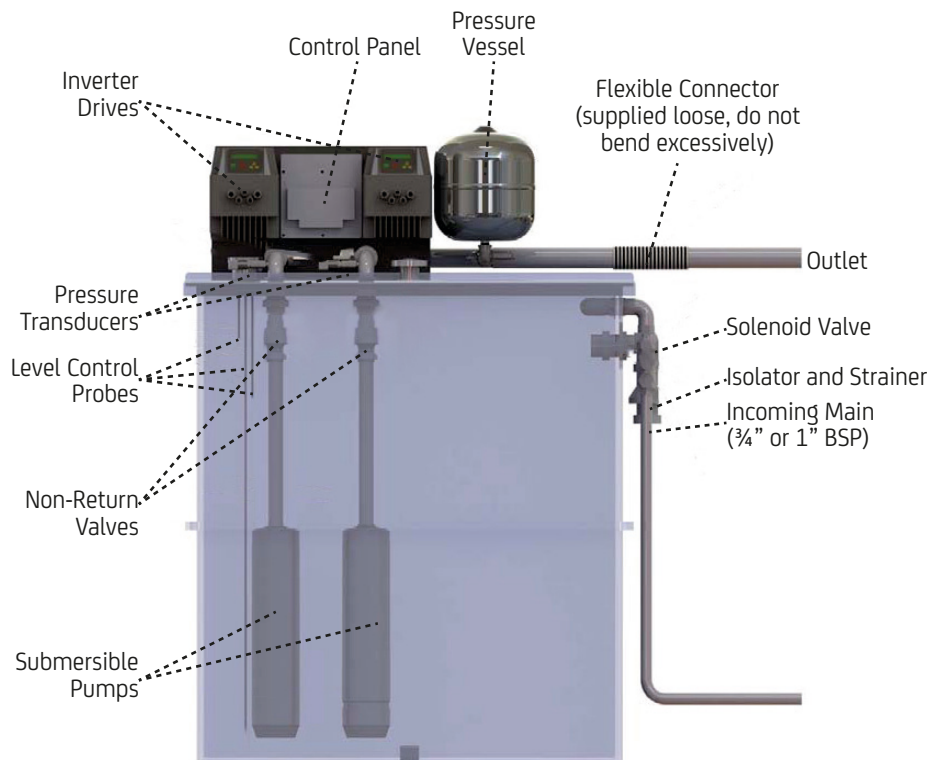
**Figure 2.3: ScubaTANK Components**

## 2.2 Pump Curves (Single Pump)

Figure 2.4: WXx-3000 Series Pump Curves

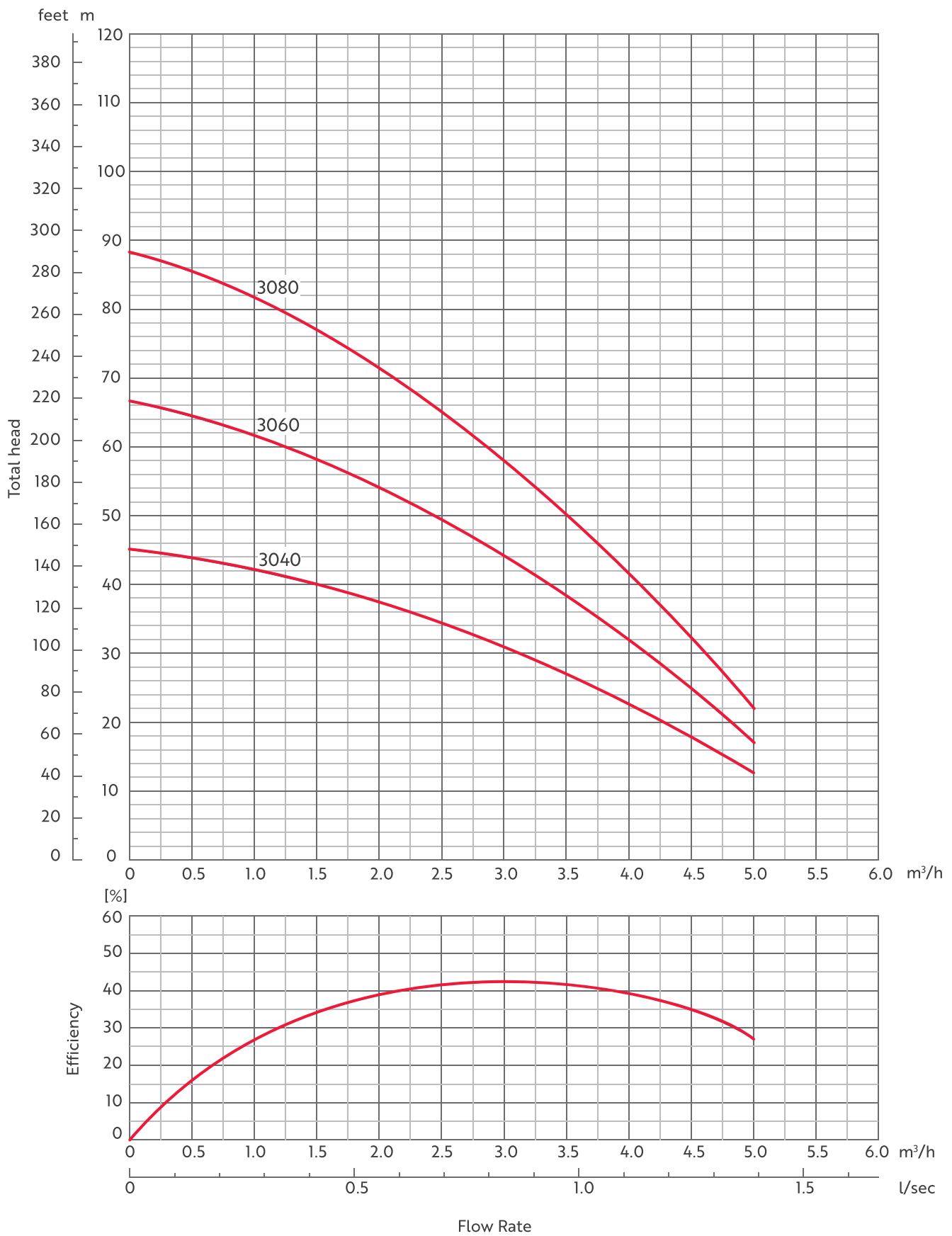

**Figure 2.5: WXx-5000 Series Pump Curves**

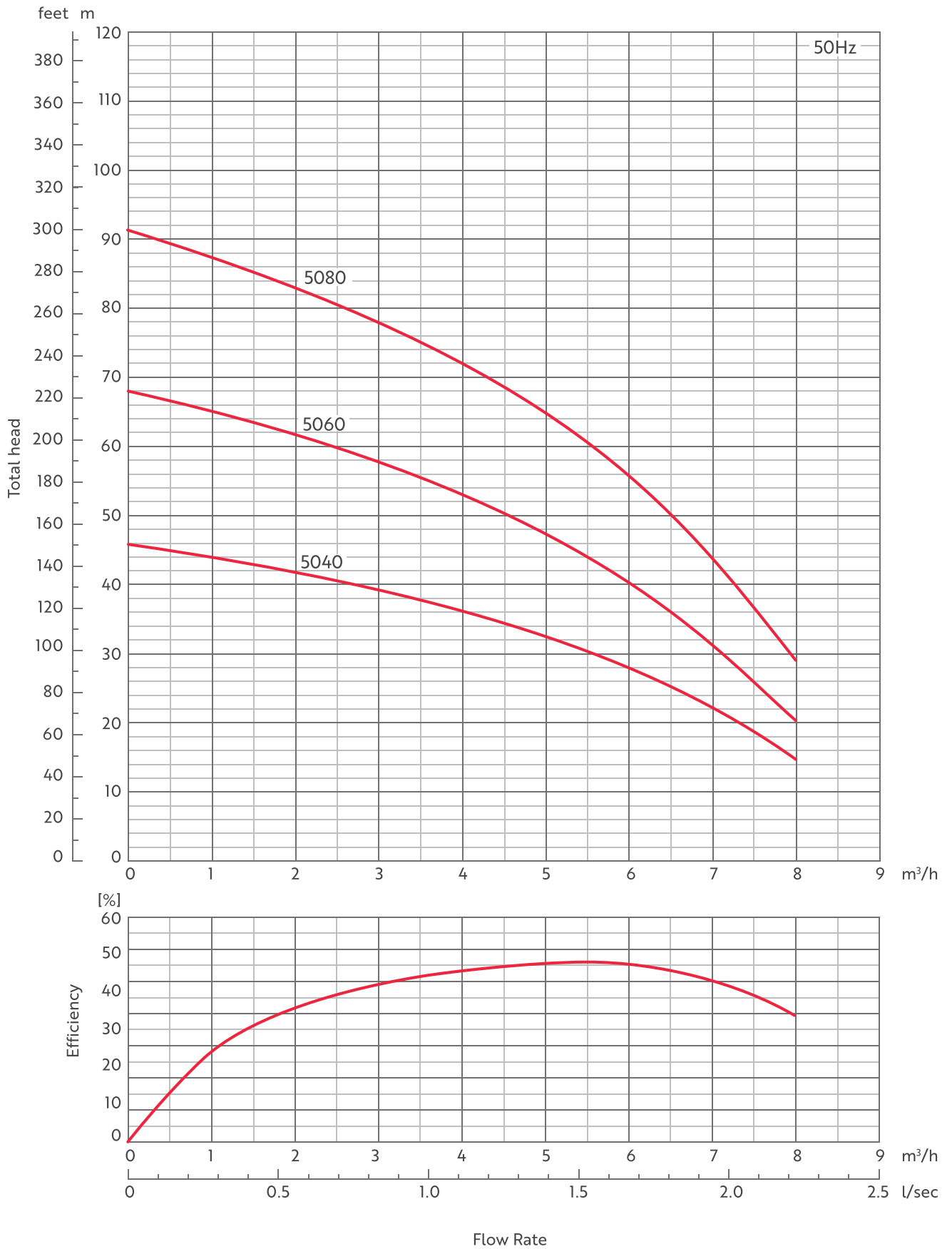
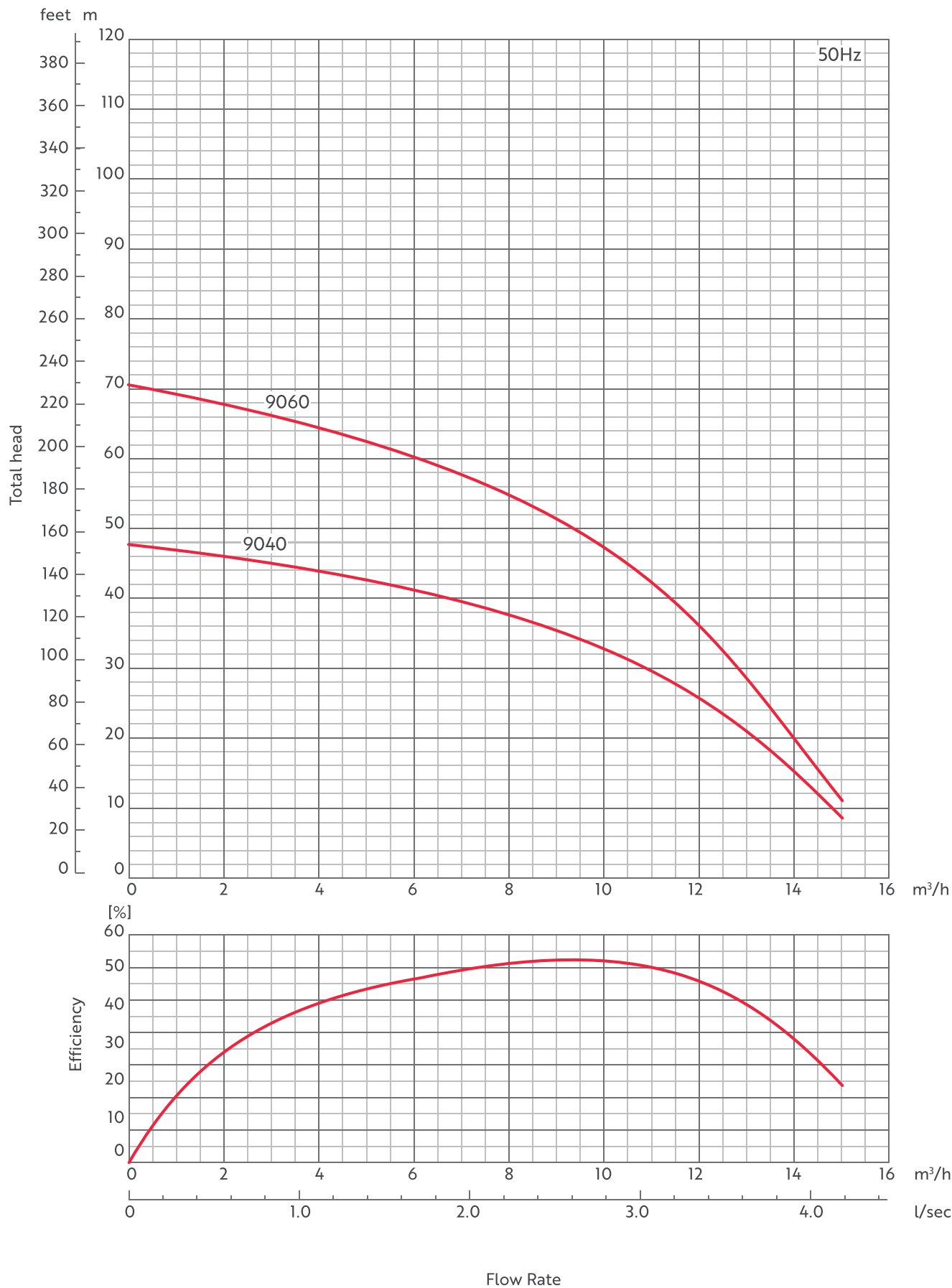

Figure 2.6: WXx-9000 Series Pump Curves





# 3. Installation Sequence

## 3.1 Position and Secure the Tank

note: For installation of ScubaTANK models with a horizontal split tank (model has designation -HS), first follow the instructions in Section [3.5 Horizontal Split Tank Installation \(Applicable to -HS Models\)](#) (p. 18) before returning to this section.

- 1) Connect all hydraulic connections - see Section [3.3 Hydraulic Connection](#) (p. 17)
- 2) Connect the electrical supply cable from a fused supply with correct rating - see Section [3.4 Electrical Supply](#) (p. 17)
- 3) Fill the system and vent the pump(s)
- 4) Test and commission - see Section [4. Commissioning](#) (p. 24).

**NOTE:** The ScubaTANK must be installed on a stable, level surface or plinth capable of supporting the tank and liquid.

**Table 3.4:** ScubaTANK Dimensions and Weights

Tank Size (l)	Footprint (mm)	Overall Height (mm)	Height to Top of Open Tank (mm)	Weight When Empty (kg)	Weight When Full (kg)
175	600 × 600	1414	1000	59	234
375	600 × 900	1703	1200	117	492
440	600 × 900	1500	1200	127	492
490	600 × 900	1703	1200	117	492
575	600 × 900	1500	1200	127	492
650	750 × 1200	1703	1200	150	800
750	750 × 1200	1500	1200	160	800
800	1160 × 1160	1503	1000	165	965
1050*	800 × 1500	2003	1500	170	1,220
1250*	1160 × 1160	2003	1500	194	1,444
1650*	1160 × 1500	2003	1500	211	1,861
2250*	1160 × 2000	2003	1500	218	2,468

\*Additional overflow warning pipe: ¾" push fit

**NOTE:** An additional 250mm minimum clearance is required above the overall height

**NOTE:** Inlet centre: 62mm below the open tank top height

- The area should be dry, frost-free and well ventilated, away from extremes of temperature. All pipework must be adequately protected from freezing.
- Adequate provision should be made for drainage, leakage damage protection and service access.
- The tank is free standing and is provided with fixing feet for secure fastening to the floor.

## 3.2 Cleaning the Filter

This check is required every 6 months for the first year of operation as the system may still contain sediment. After this, an annual check is normally sufficient to keep the filter clear of sediment.

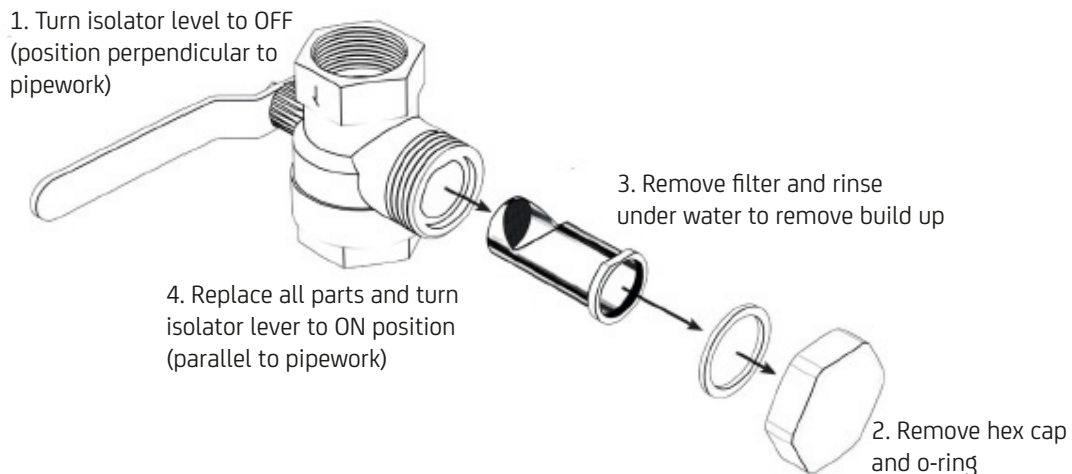

**Figure 3.7: Filter Cleaning Process**

### 3.3 Hydraulic Connection

**NOTE:**

- The discharge pipework must be sized according to the system demand.
  - All pipework must be in accordance with local Water Authority regulations.
  - All pipework must be securely supported and not over-stressed.
  - The overflow and the warning pipe (if fitted) must be piped to a suitable location.
- 1) Connect the inlet water supply via an isolation valve;
  - 2) Connect the overflow system to a suitable drain;
  - 3) Connect the warning pipe (where fitted) and pipe to a suitable location;
  - 4) Connect the outlet pipe;

### 3.4 Electrical Supply

---

**WARNING: ALL ELECTRICAL WORK MUST BE CARRIED OUT BY A SUITABLY QUALIFIED PERSON FOLLOWING THE LATEST IEE REGULATIONS**

- The system must only be operated when it has been correctly earthed and pipes bonded to earth in accordance with the latest IEE regulations
- 

**WARNING: CONTROLLER ELECTRIC SHOCK DANGER. THE CONTROLLER CONTAINS HIGH VOLTAGE**

- Never open the controller or work with any electrical connections within it unless the electrical supply to the unit is isolated.
  - Wait a further 2 minutes after isolation for the internal circuitry to discharge.
- 
- The electrical supply feed to the ScubaTANK should be a dedicated line to minimise electromagnetic interference.
  - The electrical supply rating must be at least double the FLC, assuming all pumps operate together (see [Table 3.5: ScubaTANK Breaker Ratings](#) (p. 18).)
  - The control panel isolator cable should be connected via a suitably rated external MCB.
-

**Table 3.5:** ScubaTANK Breaker Ratings

Pump Model	Pump FLC	Single Pump ScubaTANK Model	Twin Pump ScubaTANK Model	WX1 (Single Pump) Breaker Rating	WX2 (Twin Pump) Breaker Rating
3040	4.1	WX1-3040-xxx	WX2-3040-xxx	10 (1~)	20 (1~)
3060	5.2	WX1-3060-xxx	WX2-3060-xxx	10 (1~)	20 (1~)
3080	7.4	WX1-3080-xxx	WX2-3080-xxx	10 (1~)	20 (1~)
3100	5.5	WX1-3100-xxx	WX2-3100-xxx	10 (1~)	20 (1~)
5040	5.0	WX1-5040-xxx	WX2-5040-xxx	10 (1~)	20 (1~)
5060	7.4	WX1-5060-xxx	WX2-5060-xxx	10 (1~)	20 (1~)
5080	10.5	WX1-5080-xxx	WX2-5080-xxx	10 (1~)	20 (1~)
5100	9.0	WX1-5100-xxx	WX2-5100-xxx	16 (1~)	32 (1~)
9040	10.5	WX1-9040-xxx	WX2-9040-xxx	10 (1~)	20 (1~)
9060	11.9	WX1-9060-xxx	WX2-9060-xxx	16 (1~)	32 (1~)
9070	5.9	WX1-9070-xxx	WX2-9070-xxx	16 (3~)	32 (3~)
9090	6.8	WX1-9090-xxx	WX2-9090-xxx	16 (3~)	32 (3~)

**NOTE:** The probe relay settings are factory preset and should conform with information in the wiring diagram. Adjustment will invalidate the warranty.

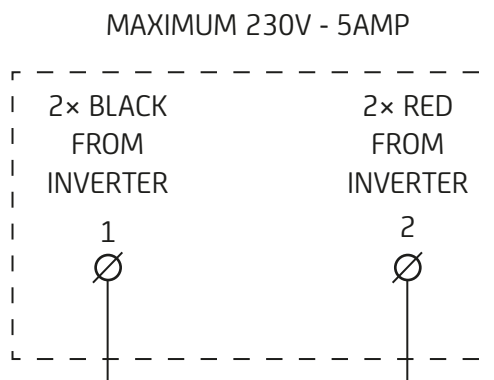
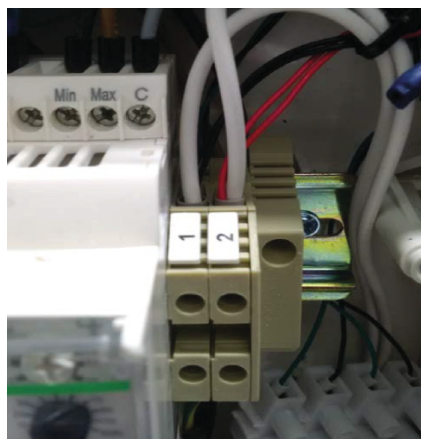
**Figure 3.8:** Common Fault Volt Free Contact Wiring Details

### 3.5 Horizontal Split Tank Installation (Applicable to -HS Models)

**NOTE:** This section applies only to ScubaTANK WX models with horizontal split tanks. These have the -HS designation.

- 1) Disassemble system
  - a) De-wire pump(s) from control panel
  - b) Remove pump(s) by opening lid and loosening union
  - c) Remove all 4 level probes
  - d) Disconnect solenoid valve power connector
  - e) Remove tank lid
  - f) Loosen bolts along horizontal split to allow the tank sections to be separated

- 2) Position all sections at location of final installation
- 3) Reassemble system
  - a) Replace lid
  - b) Place tank sections together, following instructions in [3.6 Horizontal Split Tank Assembly](#) (p. 19).
  - c) Replace tank lid assembly and screw down
  - d) Reconnect solenoid valve power connector
  - e) Replace all level probes - refer to [3.8 Level Probe Details](#) (p. 20).
  - f) Connect pump(s) to union and tighten
  - g) Re-wire pump(s) to control panel

**NOTE:** Ensure you follow the procedure according the images and instructions below.

## 3.6 Horizontal Split Tank Assembly

---

### **WARNING**

#### **The flange sealant is very adhesive**

- Ensure it is aligned correctly before applying it to the flange.
  - Remove paper backing as you progress along the flanges
  - Check that you have the correct number of fixing components, i.e. nut, bolt, washers and arboseal.
  - Ensure the flanges are free from grease and grit or other substances which may damage or prevent the flange sealant from sticking,
  - Ensure the flange sealant black strip is applied approx 5mm from the inner edge of the flange, water side.
-

**Figure 3.9:** Applying split tank sealant

Nut and bolt arrangement.



Ensure flanges are clean and free from grease, grit etc.

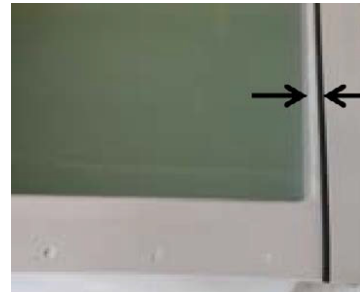

Apply flange sealant ensuring the black strip is water side.



When applying sealant to the next flange, ensure a overlap.

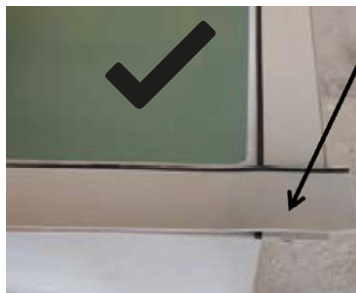

Flange sealant overlaps like this.

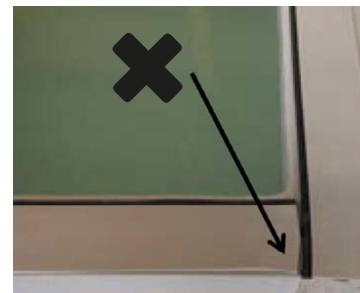

DO NOT LEAVE A GAP BETWEEN SEALS



Note: some sealant may squeeze out from between the flanges. This is normal.

When the flange seals have been applied to the bottom section, the top section of the tank is carefully lifted onto it. A podger/screwdriver may be used to align the bolt holes by pushing it through the top flange hole, through the flange seal and through the lower flange hole. A bolt may be pushed through to hold it in place while the other holes are located. It is recommended that all bolts are pushed through before tightening begins. Recommended torque: 40Nm (30lb/ft)

After all the nuts have been spun onto the bolts by hand, you may begin tightening sequentially from the first bolt to its diagonal opposite and continue in a clockwise or anticlockwise direction.

- 1) First time around, just pinch the nuts with a spanner;
- 2) Second time around, apply 30% recommended torque;
- 3) Third time around, apply 60% recommended torque;
- 4) Fourth time around, apply 100% recommended torque.

### 3.7 Bolt Tightening Sequence for Split Tank Flange Assembly

### 3.8 Level Probe Details

There are 5 terminals within the probe holder:

**Table 3.6:** ScubaTANK Level Probe Holder Details

E1	Solenoid Cut-Off Probe	Shortest probe (300mm)
E2	Solenoid Cut-In Probe	100mm longer than the cut out probe
E3	Low Level Probe	50mm shorter than the common probe
E4	Common Probe	Longest probe
E5	Note used in standard ScubaTANK models	

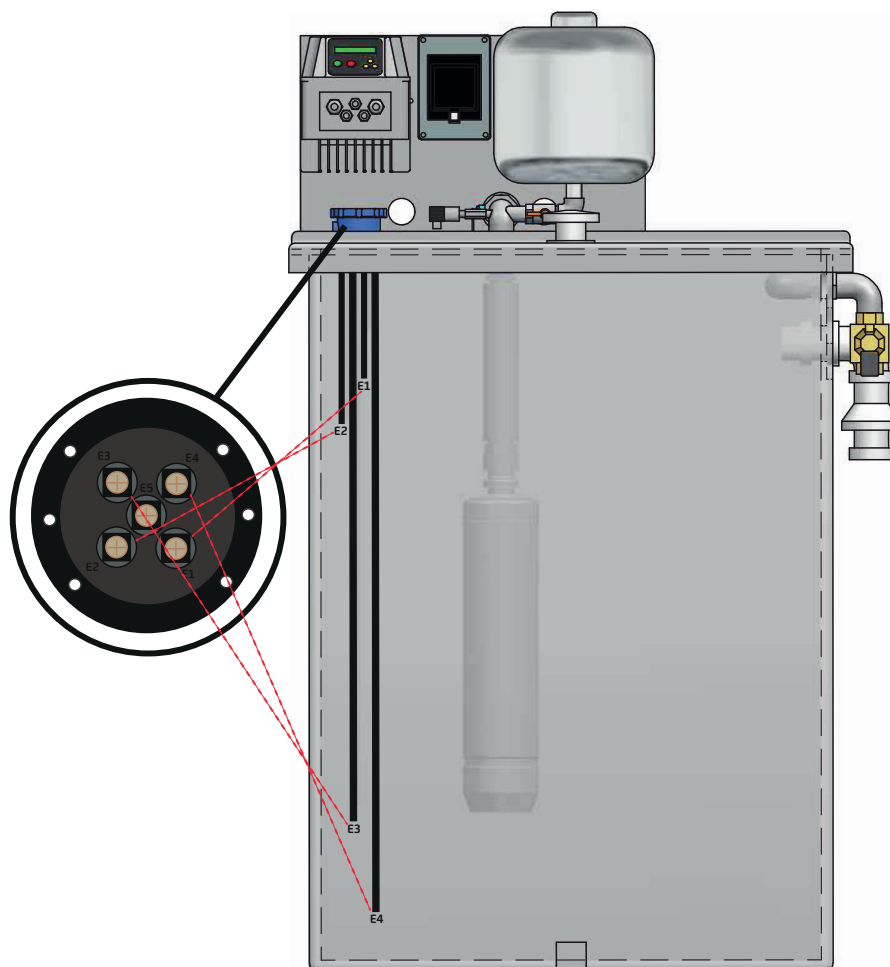
**Figure 3.10:** ScubaTANK Probes**Table 3.7:** ScubaTANK Level Probe Lengths and Part Codes

ScubaTANK Capacity (l)	175, 800		375, 490, 650		1050, 1250, 1650, 2250	
	L	Part Code	L	Part Code	L	Part Code
E4 Common Probe Length	890	SS316-890-PR-M6	1090	SS316-1090-PR-M6	1390	SS316-1390-PR-M6
E3 Low Level Probe Length (mm)	840	SS316-840-PR-M6	1040	SS316-1040-PR-M6	1340	SS316-1340-PR-M6
E2 Solenoid Cut-In Probe Length (mm)	400	SS316-400-PR-M6	400	SS316-400-PR-M6	400	SS316-400-PR-M6
E1 Solenoid Cut-Out Probe Length (mm)	300	SS316-300-PR-M6	300	SS316-300-PR-M6	300	SS316-300-PR-M6

## 4. Commissioning

### 4.1 Installation and commissioning overview

Before shipment, all Dutypoint pump sets are pre-commissioned. Whilst important procedures such as venting and rotational direction checks need to be carried out on site, initial parameters including pressure settings and delay timers will be adjusted to suit the site conditions previously advised to Dutypoint.

In practice, a system can almost invariably be made to perform more efficiently if further re-commissioning is carried out on site.

Please note that engineer visits by Dutypoint are priced at one visit to commission one pump set. If there are multiple units on a site, special terms can be negotiated. To arrange a commissioning visit, please call the Technical Service Help line 01452 300590.

The following checks should be carried out at the initial installation before any run tests are performed.

---

#### WARNING

- Ensure that you have read and understood Section [1. Important Safety Information](#) (p. 4).
- 

### 4.2 Pipework and mechanical checks

- 1) Ensure that the mounting area and any associated groundwork provides adequate support for the pump set.
- 2) Ensure all supports/brackets are in place and secure.
- 3) Verify all pipe joints are sealed and tight.

### 4.3 Electrical checks

---

#### DANGER

- These checks MUST be carried out by a competent electrician.
  - Ensure that the power source is sufficient to allow the running of all pumps together where there are multiple pumps in the system. This also applies to 'standby' pumps.
  - Refer to Section [12. Control Panel Wiring Diagrams](#) (p. 48)
- 

- 1) Check the motor voltage and frequency information on all the motor nameplates and on controllers etc. correspond with that of the source power supply.
- 2) Check that all electrical connections are correctly made and secure. Pay particular attention to earth and bonding connections.
- 3) Carry out specific checks for earth bonding.
- 4) Carry out NICEIC certification checks as required for the installation, e.g Earth Loop Impedance, Insulation Tests, etc.

### 4.4 Final checks before commissioning

- 1) Re-check all equipment for any accidental damage caused during installation.
- 2) Carry out the pre-charging and venting procedures described next.

## 4.5 Pressure vessel pre-charging

Figure 4.11: Pressure Vessel Pre-charge

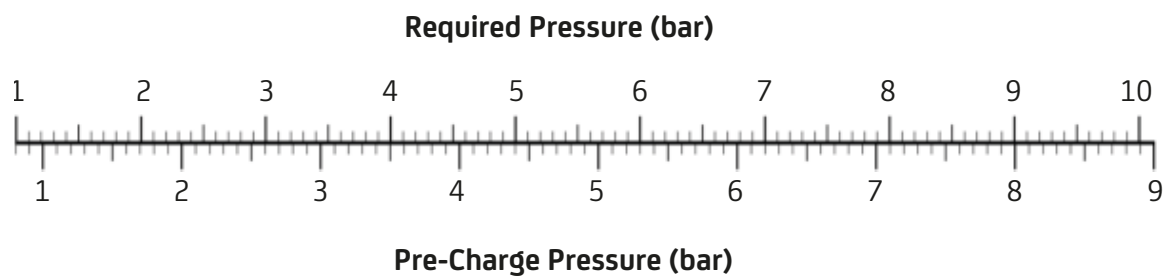

Before commissioning starts the pre-charge of the pressure vessels should be checked.

On variable speed systems the pre-charge air pressure for vessels should be 90% of the maximum pressure generated by the pump in the pipework system

e.g: If the maximum pressure generated by the pump in a system is 6 bar, this will require a pre-charge pressure of  $6 \times 90\% = 5.4$  bar.

To check and adjust the pressure vessel pre-charge:

- 1) First check that the expansion or pressure tank is totally drained of water and isolated.
- 2) Refer to [Figure 4.12: Pre-Charging a Pressure Vessel](#) (p. 25). Remove the air vent cover.
- 3) Unscrew the air valve cap.
- 4) Connect a pressure gauge. Verify that the pre-charge pressure is correct. If it is low then the vessel pre-charge must be corrected by additional inflation of the diaphragm.
- 5) When the pre-charge pressure is correct replace the air valve cap and vent cover.

Figure 4.12: Pre-Charging a Pressure Vessel

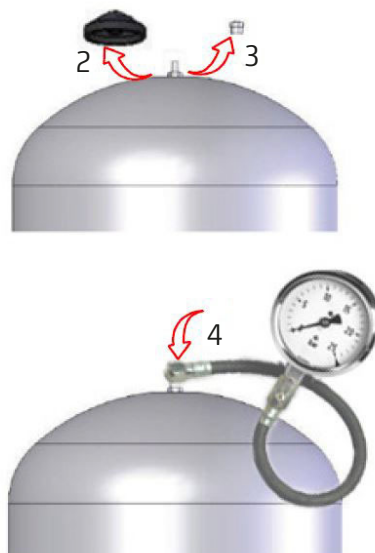

## 4.6 Programming the Controller

All ScubaTANK models are fitted with a variable speed inverter drive per pump. These are set up and pre-commissioned prior to delivery. For full details of these unites, refer to Section [13. VASCO V209 and V214 Pump Controllers](#) (p. 50)

If in doubt please call Dutypoint Systems Technical Support on 01452 300590 for advice.

## 4.7 Operation and Performance Tests

Having checked that the pump set is installed, pre-charged, vented in accordance with the procedures set out earlier, carry out the following running tests before handing over the pump set for operational use.

- 1) Create the conditions for a normal start and run and allow the selected 'Duty' pump to run. Whilst running observe the pressure values. Verify the pump motor speeds up / slows down in accordance with the desired control philosophy.

## 4.8 Duty/Standby Twin Pump Sets

- 1) On Duty/Standby sets, wait for a normal stop to take place (or create the conditions where this would happen) and check that the 'Duty' pump stops. Whilst stopped simulate a fault by inhibiting the 'Duty' pump and then recreate the conditions for a normal start to take place. Check that the 'Standby' Pump now starts and runs in place of the inhibited 'Duty' pump and observe the pressure values. Verify that the pump motor speeds up / slows down in accordance with the desired control philosophy.
- 2) Wait for a normal stop to take place (or create the conditions where this would happen) and check the 'Standby' pump stops. Whilst stopped undo the inhibit to the 'Duty' pump which should now return to normal.

## 4.9 Duty/Assist Twin Pump Sets

- 1) For 'Duty/Assist' applications, run the system up to pressure using the 'Duty' Pump only, then deliberately create the condition(s) which will require the 'Assist' Pump to operate as well. (e.g: open taps to reduce the pressure in the system to a point where one pump only cannot maintain the required output. Verify that the 'Assist' Pump starts and runs together with the 'Duty' Pump and that the desired pressure is duly restored and maintained.
- 2) Close the taps again (thereby reducing the demand) and check the 'Assist' Pump slows down and stops, allowing the 'Duty' Pump to continue on its own.

## 4.10 Commissioning/Handover Check

- 1) Record any indicated voltage / amperage / pressure data / controller passwords for future reference.
- 2) Re-check all isolating valves are fully open and replace any cover(s).
- 3) With all the isolators ON and the switches and/or control programs set to AUTO, the pump set is now fully operational in automatic control mode.

**NOTE:** No manual operation or attendance is required other than for routine servicing and maintenance checks. Other than for maintenance purposes, the supply to the Controller(s) and the Pump motor(s) should never be switched off.





# 5. Operating the Pump Set

## 5.1 VASCO Display

The display screen on the VASCO is a back-lit LCD displaying 2 rows of 16 digits each. Alarms are indicated by an audible signal.

**Figure 5.13:** VASCO Control Panel

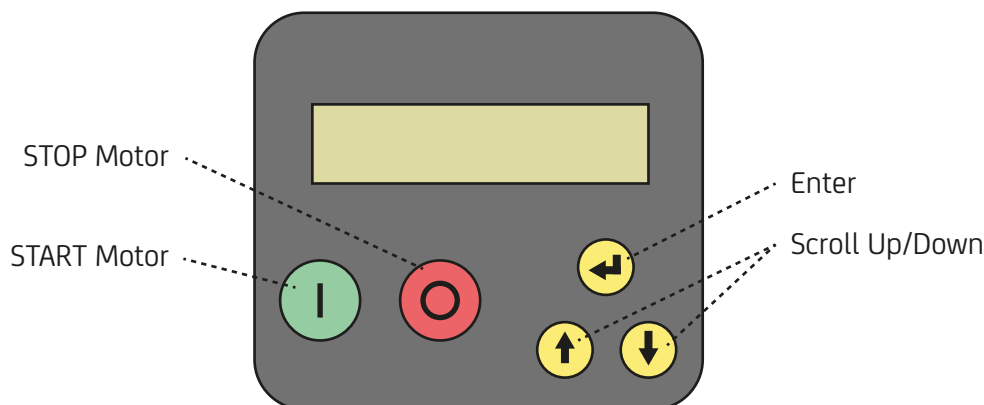

**Figure 5.14:** Display shown when first powering VASCO



**NOTE:** One pump/VASCO combination will have been set as master (display name 00) and others as slaves (e.g. display name 01). The term "INV:" will be replaced by the appropriate display name, "00:" or "01:" etc. Various messages are then displayed.

The first row of the display gives the pump status as follows:

- Inv: ON XXX.X Hz - VASCO is powered and is powering the motor, showing its frequency
- Inv: ON Mot: OFF - VASCO is powered but motor is not running (i.e. motor/pump was stopped due to minimum frequency being reached).
- Inv: OFF Mot: OFF - VASCO is not powered.

The following end user messages are displayed on the second row by pushing the scroll buttons:

**Table 5.8:** VASCO End User Messages

Inv: ON/OFF Mot: ON/OFF p = XX.X [bar]	p is the pressure value read by the pressure transducer. By pressing ENTER the pressure set vale is displayed
Inv: ON/OFF Mot: ON/OFF f = XXX [Hz]	f value is the supply frequency to the motor. On fox frequency control mode, by pressing ENTER you can change the f value manually (word "set" is displayed), press ENTER again to exit parameter setting (word "set" disappears).
Inv: ON/OFF Mot: ON/OFF V_in = XX.X [V] I=XX.X	V_in is the line voltage. This value is displayed only if motor is OFF. If motor is NO, A value equal to the absorbed motor current.
Inv: ON/OFF Mot: ON/OFF cosphi = XXX	cosphi index means the angle phi between the voltage and current absorbed by the motor

Inv: ON/OFF Mot: ON/OFF P = XXXXX [W]	P is the power in Watts supplied to the pump
Inv: ON/OFF Mot: ON/OFF STATUS: NORMAL	NORMAL status means no alarms. If an alarm occurs, a message blinks on the display and an audible signal is activated. Pressing ENTER accesses: VASCO lifetime, PUMP lifetime, consumption statistic, alarm list. To return to previous views, press ENTER.
Inverter Life xxxxx h : xx m	
Motor Life p = XX.X [bar]	
%f 25 50 75 100 %h XX XX XX XX	
XXXXXXXXXXXXXXXXXXXX XXXXXXXXXX h : XX m	

## **WARNING: ADVANCED PARAMETERS. IMPROPER SETTINGS CAN COMPROMISE THE INTEGRITY AND LIFE OF THE CONTROLLER AND PUMP**

- You should only access and adjust parameters if you are trained to do so
- All full description of the advanced parameters is available in the appendix of this manual
- For further assistance, call the Duty point Technical Service line of 01452 300590.

Pressing ENTER when you are in the initial display will show the following menus:

**Table 5.9:** VASCO Menus

MENU' Motor param.	Installer password required to enter level 1 (default 001)
MENU' Control. param.	Advanced password required to enter level 2 (default 002)
MENU' IN/OUT. param.	Installer password required to enter level 1 (default 001)
MENU' Connect. param.	Installer password required to enter level 2 (default 001)
MENU' Change init.set. param.	Advanced password required to enter level 2 (default 002)

To exit the Menu level and return to the initial display, press STOP button.

For full details on the VASCO controller see [13. VASCO V209 and V214 Pump Controllers](#).

## 6. Pressure Vessel

The pressure vessel supplied as part of your Dutypoint product is used to absorb and conserve the potential energy of pressurised liquid. Stored energy from liquid under pressure is transferred to the water system when required.

### 6.1 Installation Safety Notes

These notes are taken from the pressure vessel installation manual:

- This product is designed to hold water up to +110°C
- Never exceed the maximum working pressure and temperature of the expansion tank; ensure appropriate controls are installed for this purpose.
- During installation prepare adequate systems for drainage to limit damage caused by leakage from the tank, draining and venting.
- During installation the installer should account for external stress such as traffic, wind and earthquakes.
- Always install the appliance in conformity to current legislation.
- This product must be installed and regularly inspected by qualified personnel only.
- The manufacturer shall not be held liable for any personal or material damage caused by the product if installed and/or used improperly or in way anyhow diversely from manufacturer's specifications.
- Exceeding temperature and pressure limits specified by the manufacturer will give cause to cancel any guarantee covering the product as well as any manufacturer's liability.
- For fluids other than water, check compatibility before installing.
- The appliance must be installed in a safe place with access for authorized personnel only.
- The appliance must be protected by an appropriate earthing systems or isolated from the system by a dielectric joint.

### 6.2 Periodic Maintenance

Periodic maintenance is recommended at least twice a year and should be carried out by authorised specialised personnel only.

- 1) First check that the pressure vessel is totally drained of water, and that the system is switched off and no electrical parts are live.
- 2) Check and, if necessary reset the pre-charge pressure, using the instructions below. Ensure that the pressure does not exceed the value specified in the procedure.

### 6.3 Checking and Adjusting Pressure Vessel Pre-Charge

Before commissioning starts and during every routine service, the pre-charge of the pressure vessels should be checked according to the following chart and instructions.

**Figure 6.15:** Pressure Vessel Pre-charge

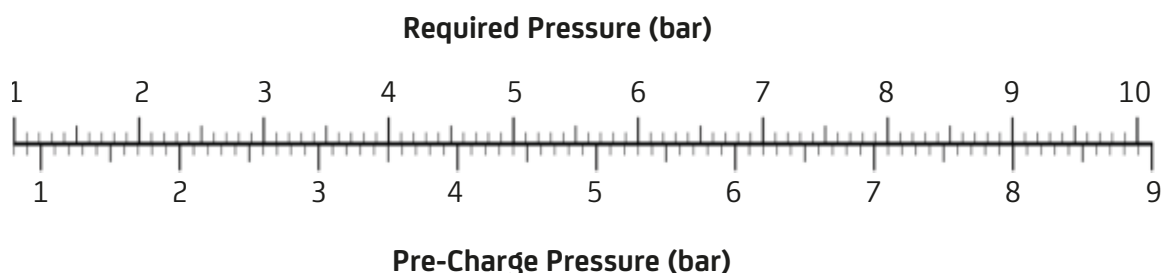

On variable speed systems the pre-charge air pressure for vessels should be 90% of the maximum pressure generated by the pump in the pipework system

e.g: If the maximum pressure generated by the pump in a system is 6 bar, this will require a pre-charge pressure of  $6 \times 90\% = 5.4$  bar.

To verify the pre-charge pressure:

- 1) First check that the expansion or pressure tank is totally drained of water and isolated.
- 2) Refer to [Figure 6.16: Pre-Charging a Pressure Vessel](#) (p. 31). Remove the air vent cover.
- 3) Unscrew the air valve cap.
- 4) Connect a pressure gauge. Verify that the pre-charge pressure is correct. If it is low then the vessel pre-charge must be corrected by additional inflation of the diaphragm.
- 5) When the pre-charge pressure is correct replace the air valve cap and vent cover.

**Figure 6.16:** Pre-Charging a Pressure Vessel

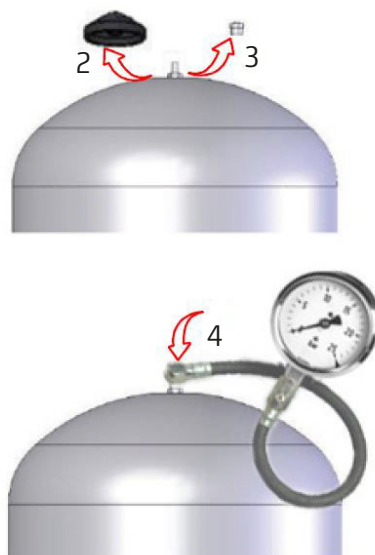

## 6.4 General Maintenance and Repair

Disconnect all electrical equipment before starting on any maintenance jobs or checking the installation pressure and temperature. The pre-charge pressure should be checked and if necessary corrected during any maintenance work.

## 6.5 Diaphragm Replacement

To replace a diaphragm:

- 1) Empty the expansion tank
- 2) Remove the pre-charging by releasing the air vent.
- 3) Loosen the M8 screws fastening the flange
- 4) Remove the flange
- 5) Extract the diaphragm and replace it

## 6.6 Installing a Replacement Vessel

Read these instructions carefully before installing the product:

- 1) Make sure the product is in good condition. If the product is damaged do not start on installation but take it back to the seller for immediate replacement.
- 2) The product must be installed in the position (vertical or horizontal) specified in the technical specifications.
- 3) While the system is cold, measure the static pressure with a gauge, at the point where the tank has to be installed.

- 4) Set the pre-charge pressure, using the procedure earlier in this section. Ensure that the pressure does not exceed the value specified in the procedure.
- 5) The appliance must be supplied with efficient and sufficient safety and control facilities, in particular the safety valve must be connected to the appliance and be free from interference and must be gauged to the quantity of fluid to be discharged. The safety valve should also be designed to ensure that the pressure does not permanently exceed the maximum tolerated pressure (a temporary pressure peak, limited to 10% of the maximum tolerated pressure, is allowed).
- 6) Make sure the cap of the valve is fitted tightly after pre-loading and that there is no leakage.



# 7. System User Maintenance

Dutypoint pump sets have been designed to keep major maintenance requirements to a minimum. Planned maintenance of the pumps and other principal components should therefore be undertaken at the intervals recommended in the manuals referenced below.

It is essential that a full test following the Pre-Commissioning procedure on is carried out on an annual basis.

In addition, the operator in charge should routinely make visual checks of the equipment during use, noting particularly any unusual noises or vibrations. This will give an immediate indication of any irregularity in the operation of the system.

## DANGER!

**Do not commence any work until:**

- You have read [1. Important Safety Information](#) (p. 4)
- You have the appropriate personal protective equipment
- You have all necessary safety equipment to hand

Refer to the appropriate manufacturer's information that is provided in the appendices of this manual for the equipment being serviced.

**Table 7.10:** Periodic User Checks for Pump Sets

Timing	Checks
Weekly	<ol style="list-style-type: none"> <li>1) Visually check the complete pump set</li> <li>2) Observe the running of the pump(s) and note any unusual vibrations or sounds.</li> </ol>
Quarterly	<ol style="list-style-type: none"> <li>1) Visually check the complete pump set</li> <li>2) Observe the running of the pump(s) and note any unusual vibration, etc.</li> <li>3) Check the cooling fan and vents on the Control Unit(s) and clear any dust or other obstructions</li> <li>4) Operate each manual isolating valve three times to ensure continued efficient working</li> </ol>
6-monthly	<ol style="list-style-type: none"> <li>1) The pressure vessel should be drained and the pre-charge pressure checked. See <a href="#">6.3 Checking and Adjusting Pressure Vessel Pre-Charge</a> (p. 30) for more details.</li> <li>2) The water storage tank should be checked for signs of stagnation, infection or contamination.</li> </ol>
12-monthly (essential)	Carry out the full pre-commissioning procedure to verify safe operation - see <a href="#">4. Commissioning</a> (p. 24).





---

# 8. Pump Maintenance

The following information is an extract from the pump manufacturer's documentation.

## 8.1 Routine maintenance

The pump requires no detailed maintenance except to:

- Periodically verify that the suction grate is clear
- Periodically with the power off, check the condition of the cables and electrical power and earth connections.

## 8.2 Pump replacement

---

### DANGER!

#### Risk of electric shock

- Before beginning any work on the pump you must isolate the electrical supply and make sure that it cannot be accidentally reconnected.
  - Wait for a further 2 minutes for the internal circuitry to discharge BEFORE opening or working with any electrical connections.
  - It is the installer's responsibility to ensure that the installation is in compliance with local regulations and all electrical guidelines.
- 

### WARNING

**Electrical pumps should never be used outside the limitations described in the technical specifications**

- Replacement pumps should remain in their original packaging until installation.
- 

## 8.3 Replacement procedure

- 1) Before installation, check the new pump and verify its integrity and that it is the correct type/rating. Contact the supplier if there are any anomalies.
- 2) Locate the 4× plastic screw covers protecting the M6 screws securing the tank lid. Remove the covers and screws and lift off the tank lid to access the old pump.
- 3) Disconnect the pump pipework.
- 4) Disconnect the pump electrical cable, noting the cable colour coding.
- 5) Insert the replacement pump into the tank and reconnect the pipework.
- 6) Feed the pump cable through the watertight glands and make the electrical connections to the controller as noted in step 4 above, verifying that the earth connection is securely made.
- 7) Fix the power cable to the delivery pipe using suitable strap.
- 8) Replace the covers on the controller.
- 9) Test the system, checking rotation direction (see below).
- 10) When testing is complete, replace the tank lid and screw it down, refitting the plastic caps

---

### WARNING: EXCESSIVE FORCE CAN DAMAGE EQUIPMENT

- To avoid damage, do not use excessive force when screwing the pipe to the pump discharge outlet.
-

## 8.4 Checking the direction of rotation

**NOTE:** This operation will be performed dry and must not last more than a few seconds.

If the direction of rotation is reversed due to incorrect connection or controller programming, the pump performance will be significantly lower than the nominal values. To verify a correct connection, proceed as follows:

- 1) Start the electrical pump before it is submerged. Correct rotation is in a counter-clockwise direction as viewed from above.
- 2) With the pump operating, installed and submerged, use a clamp meter to measure the current. If the rotation is reversed, you will see values about double those indicated on the name plate.
- 3) Correct before using the system.

# 9. Pressure Set Point Adjustment

**NOTE:** This procedure should only be undertaken by an experienced and qualified installer or engineer. Failure to follow the procedure correctly may cause damage to the product and invalidate any product warranty. The installer is responsible for ensuring that the required value is suitable for the product. Check [2.2 Pump Curves \(Single Pump\)](#) (p. 12) prior to adjustment.

**NOTE:** For twin-pump WX2 systems, these instructions refer to the master controller which has INV00 in the top right corner of the display.

- 1) Press STOP button (red) - refer to [Figure 9.17: VASCO Control Panel](#)
- 2) Press the down arrow until you see 'MENU / ENT TO ACCESS' then press the ENTER button.
- 3) You will open the 'INSTALLER PARAMETERS' or 'CONTROL PARAMETERS' menu (depending on model). Press the ENTER button again.
- 4) You will be promoted to enter the password. Press ENTER again until the last zero flashes, then press the up arrow to show a '1' - the default password is 001. Press ENTER again.
- 5) Press the DOWN arrow until you see 'SET VALUE', then press ENTER again.
- 6) Use the UP and DOWN arrows to adjust the pressure to the required value.
- 7) Press ENTER to save the value then:
  - Single pump models: press the RED STOP button three times to return to HOME screen, then press GREEN START button
  - Multi-pump models: press the RED STOP button twice, then ENTER to transfer settings to the SLAVE inverter(s)
- 8) Follow the instructions to adjust the pressure vessel pre-charge to suit the new required value - see [6.3 Checking and Adjusting Pressure Vessel Pre-Charge](#) (p. 30).

**Figure 9.17:** VASCO Control Panel

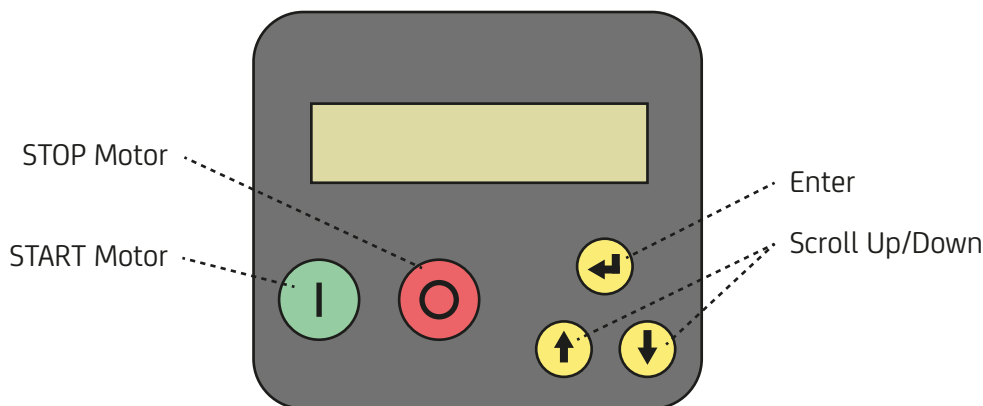



# 10. Frequently Asked Questions

## 10.1 Where are the common fault terminals in a ScubaTANK?

See [Figure 3.8: Common Fault Volt Free Contact Wiring Details](#) (p. 18)

## 10.2 Does the ScubaTANK have an enable/disable signal input?

Yes, these are the blue and black cables crimped off in the bottom of the control panel. Note: these are not volt-free.

## 10.3 How do I reset a 'NO WATER' error on a ScubaTANK?

See [Table 11.11: Common Error Messages](#) (p. 42)

## 10.4 How do I pre-charge a pressure vessel to the correct pressure?

See [6.3 Checking and Adjusting Pressure Vessel Pre-Charge](#) (p. 30)

## 10.5 How do I change the pressure set point?

See [9. Pressure Set Point Adjustment](#) (p. 38)



# 11. Troubleshooting

Troubleshooting VASCO-equipped booster sets. The information in this section is common to all VASCO-equipped Duty point booster sets. For more detailed troubleshooting information that is specific to the type and model of pump controller used, please refer to the manufacturer's literature in the Appendix.

## WHEN A FAULT FIRST OCCURS:

- Turn off the main power to the pump set and leave off for 1 minute
- Switching power back on and re-energising the system may be sufficient to clear the fault

**WARNING: IF PUMP COSPHI IS LOWER THAT THE DRY-RUNNING COSPHI FOR AS LEAST 2 SECONDS, VASCO WILL STOP THE PUMP. VASCO WILL TRY TO RUN THE PUMP AT 10, 20, 40, 80 AND 160 MINUTES, THEN THE PUMP WILL STOP. IF DRY RUNNING PROTECTION OCCURS, VASCO WILL ATTEMPT TO START THE PUMP AUTOMATICALLY**

- Cut the power supply before performing any maintenance
- VASCO will stop the pump if the input motor current is higher than the set motor current for an extended time. By pressing the START button it is possible to run the pump again.
- VASCO will stop the pump if the input voltage is higher than the set voltage for an extended time. By pressing the START button it is possible to run the pump again. VASCO will stop the pump if the input voltage is lower than the set voltage for an extended time. By pressing the START button it is possible to run the pump again.

**Table 11.11: Common Error Messages**

Message	Possible Cause(s)	Solutions
ACTIVE DIG. IN. 1	Digital input 1 contact is opened - system indicates 'External On/Off'	<ol style="list-style-type: none"> <li>1) Verify that an external signal (e.g. BMS) is set to deactivate the pump set</li> <li>2) The error should reset automatically when Digital Input 1 contact is closed</li> </ol>
ACTIVE DIG. IN. 3	Digital input 3 contact is opened - system indicates 'Low Water Level'	<ol style="list-style-type: none"> <li>1) Check incoming mains pressure is as expected</li> <li>2) Check water level in tank.</li> <li>3) The error should reset automatically when Digital Input 3 contact is closed</li> </ol>



Message	Possible Cause(s)	Solutions
NO WATER- (DRY RUN COSPHI )	Minimum pressure requirement not reached within set period	<ol style="list-style-type: none"> <li>1) Turn off main electrical isolator</li> <li>2) Close discharge isolation valve</li> <li>3) Vent pumps</li> <li>4) Turn on main electrical isolator</li> <li>5) Check unit runs up to set pressure and pump motors shut down</li> <li>6) Open discharge valve slowly ensuring set pressure is maintained</li> </ol>
	Air lock in pump	<ol style="list-style-type: none"> <li>1) Press the red STOP button on the inverter drive(s) to stop the unit.</li> <li>2) Disconnect the pump(s) by loosening the union directly underneath the lid, above the pump discharge pipeline.</li> <li>3) Lean/tilt the pump(s) over as far as possible to enable air to escape.</li> <li>4) Reconnect the pump union(s).</li> <li>5) Press the green START buttons to resume normal operation.</li> <li>6) Verify normal operation.</li> </ol>
	No water in break tank	<ol style="list-style-type: none"> <li>1) Check incoming mains pressure is as expected;</li> <li>2) Check the water level in the tank.</li> </ol>

Table 11.12: Fault Finding

Problems	Possible Causes	Solutions
Pump will not start	No electrical power	Check and rectify
	Blown fuse	Check and rectify
	Overload trip/MCB	Check and (if necessary) reset the overload trip value.
Low (or zero) output discharge rate	The rotating part(s) of the pump is/are partially or completely obstructed e.g: impeller obstructed by foreign matter	Strip the pump to inspect and rectify
	Pump not primed - WARNING: running the pump 'dry' can cause serious damage to the mechanical seal.	Having first checked the mechanical seal for damage, prime and air-bleed the pump and try again
	Valve in suction pipework closed or partially closed	Check all appropriate valves are fully open.
	Incorrect pump rotation	Check and rectify.
Pump vibrates and/or is noisy	Pump is cavitating	Increase the discharge back pressure slightly by progressively closing a manual isolating valve on the discharge side until the cavitation stops.
	The rotating part(s) of the pump is (are) partially or completely obstructed. e.g: impeller obstructed by foreign matter.	Strip the pump to inspect and rectify
	Motor bearings worn	Check and rectify

Problems	Possible Causes	Solutions
Overload Trip	Pipework or the pump chamber has a partial blockage.	Check and rectify
	Momentary loss of one phase of power supply	Check and try again
	Discharge flow rate too high	Reduce the discharge flow rate by increasing the discharge back pressure slightly, progressively closing a manual isolating valve on the discharge side, then try again
	Overload trip setting too low for rated duty	Check and (if necessary) reset the overload trip value
Pump Runs Continuously	Contact Dutypoint Service on 01452 300590	
Break Tank Overflowing (ScubaTANK WX models only)	Solenoid valve jammed open due to debris	<p>Clean the solenoid valve diaphragm by following this procedure:</p> <ol style="list-style-type: none"> <li>1) Press red STOP button(s) on inverter control panel(s)</li> <li>2) Close incoming isolation valve</li> <li>3) Isolate electrical supply</li> <li>4) Loosen 4 screws as shown in <i>Figure 11.18: Cleaning Solenoid Valve Diaphragm (ScubaTANK WX Models Only)</i> (p. 45)</li> <li>5) Remove diaphragm and spring shown in <i>Figure 11.18: Cleaning Solenoid Valve Diaphragm (ScubaTANK WX Models Only)</i> (p. 45)</li> <li>6) Remove all dirt from diaphragm and housing</li> <li>7) Replace all parts</li> </ol>
	Probe relay settings have been adjusted	Check the probe relay settings according to <i>Figure 11.19: Correct Probe Relay Settings (ScubaTANK WX Models Only)</i> (p. 45) in the control panel. Note: these settings should never normally be adjusted. Only change them to match the required settings shown.
	Loss of power to probe relays	Check for the two green lights marked 'Un'. If either are not illuminated there is a problem with the power supply to the probe relays. Contact Dutypoint Technical Service on 01452 300590 for assistance.

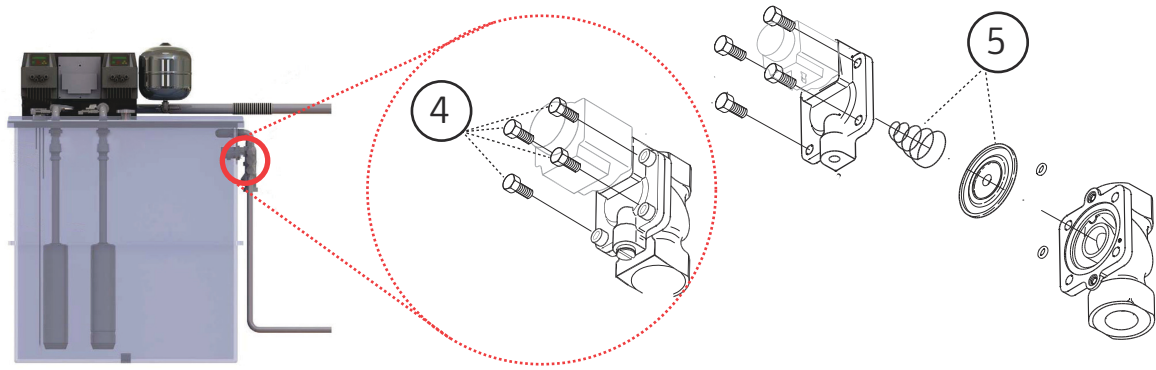
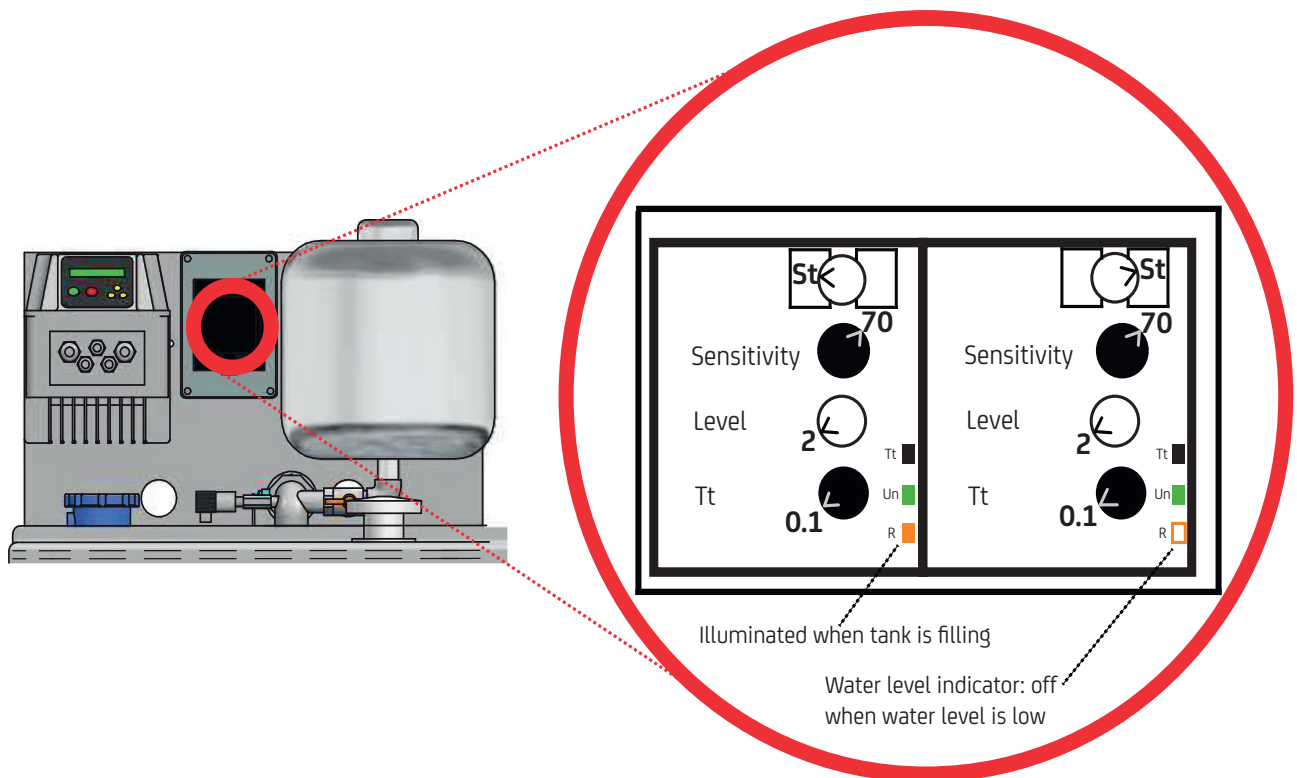
**Figure 11.18: Cleaning Solenoid Valve Diaphragm (ScubaTANK WX Models Only)****Figure 11.19: Correct Probe Relay Settings (ScubaTANK WX Models Only)**

## 11.1 Fault Codes: Advanced

### WARNING

Improper settings can compromise the integrity and life of the controller and pump

- You should only access the Installer and Advanced menus if you are trained to do so;
- A full description of these is available in the Appendix to this manual;
- For further assistance, call the Dutypoint Technical Service line on 01452 300590.

Table 11.13: VASCO Controller Alarm Messages

Message	Alarm Description	Possible Solutions
OVERCURRENT MOT.	Motor overload: input current of the motor is higher than the rated motor current setting parameter. Motor voltage drop caused by the inverter causes the motor input current to be higher than rated. Contact motor manufacturer to check if motor is capable of accepting this current.	<ul style="list-style-type: none"> <li>Make sure that the motor current setting parameter is higher than rated.</li> <li>Add 15% to the motor current setting</li> <li>Reset the inverter using the red STOP button, then attempt to run the pump system again.</li> </ul>
NO WATER (DRY RUN COSPHI)	Motor cosphi is lower than the set value of dry running cosphi	<ul style="list-style-type: none"> <li>Check pump is primed</li> <li>Check the set value of dry running cosphi. Dry running cosphi is approximately 60% of the rated cosphi (at rated frequency) listed on the motor plate.</li> </ul> <p>If pump's cosphi is lower than the set dry-running cosphi for at least 2 seconds, VASCO stops the pump. VASCO will then attempt to run the pump every 10, 20, 40, 80, 160 minutes and then the pump is stopped.</p> <p>Note: see dry running warning statement <i>Warning: if pump cosphi is lower than the dry-running cosphi for at least 2 seconds, Vasco will stop the pump. Vasco will try to run the pump at 10, 20, 40, 80 and 160 minutes, then the pump will stop. if dry running protection occurs, Vasco will attempt to start the pump automatically.</i></p>
OVER TEMP. INV.	Inverter over temperature	<ul style="list-style-type: none"> <li>Make sure than ambient temperature is less than 40°C (104 °F).</li> <li>Check if auxiliary cooling fan is working properly and if mounting space is adequate for proper cooling.</li> <li>Reduce the PWM value (Advance Parameter Menu)</li> </ul>
NO COMMUNICATION	Communication between Master and slave(s) has been interrupted	<ul style="list-style-type: none"> <li>Check the wiring connections</li> <li>Make sure that Master is not in the menu level. If so, exit from the menu level.</li> <li>In the STATUS of the slave (where alarm is displayed). Try to reset the alarm by pushing the STOP button.</li> <li>Check each inverter is addressed correctly: <ul style="list-style-type: none"> <li>a) Master = 00</li> <li>b) Slave 1 = 01</li> <li>c) Slave 2 = 02, etc.</li> </ul> </li> </ul>
MIN. VALUE ALARM	Measured value has reached the lowest value accepted by the system.	<ul style="list-style-type: none"> <li>Check possible causes reaching minimum. value (i.e. broken pipe, open pressure relief valve, etc.)</li> <li>Check the minimum alarm value setting</li> </ul>
IGBT TRIP ALARM	The current drawn by the load exceeds the capacity of VASCO. VASCO is still able to continue to power the load for 10 minutes with an output current of 101% of nominal and for 1 minute with an output current of 110% of nominal	<ul style="list-style-type: none"> <li>Increase the ramp-up time</li> <li>Make sure that the load current is at least 10% below the VASCO nominal current</li> <li>Check the voltage drop along the supply cable to the motor</li> </ul>

Message	Alarm Description	Possible Solutions
OVER VOLTAGE	Supply voltage too high	Check possible causes of over voltage
UNDER VOLTAGE	Supply voltage too low	Check possible causes of under voltage
ADDRESS ERROR	Same address as other VASCOs in the group	The address of each VASCO needs to be different.
ALARM SLAVE XX	Slave XX error detected by master	Check the status of the slave.
SENSOR FAULT	Sensor error	<ul style="list-style-type: none"> <li>• Check the pressure transducer</li> <li>• Check the wiring of the transducer</li> </ul>
NO LOAD	No load	Check is load is properly connected to VASCO terminals
MAX. VALUE ALARM	Measured value has reached the maximum value accepted by the system.	<ul style="list-style-type: none"> <li>• Check possible causes of reaching maximum value</li> <li>• Check the max. alarm value setting</li> </ul>
KEYBOARD FAULT	A button on the keyboard has been pressed for more than 150 seconds.	<ul style="list-style-type: none"> <li>• Make sure buttons are not depressed.</li> <li>• If problem persists, call Dutypoint Technical Service on 01452 300590.</li> </ul>
ACTIVE DIG.IN.X	Digital input X opened/closed	Check the input digital configuration (IN/OUT parameters menu)

# 12. Control Panel Wiring Diagrams

Figure 12.20: Single Pump System Wiring Diagram (WX1 models)

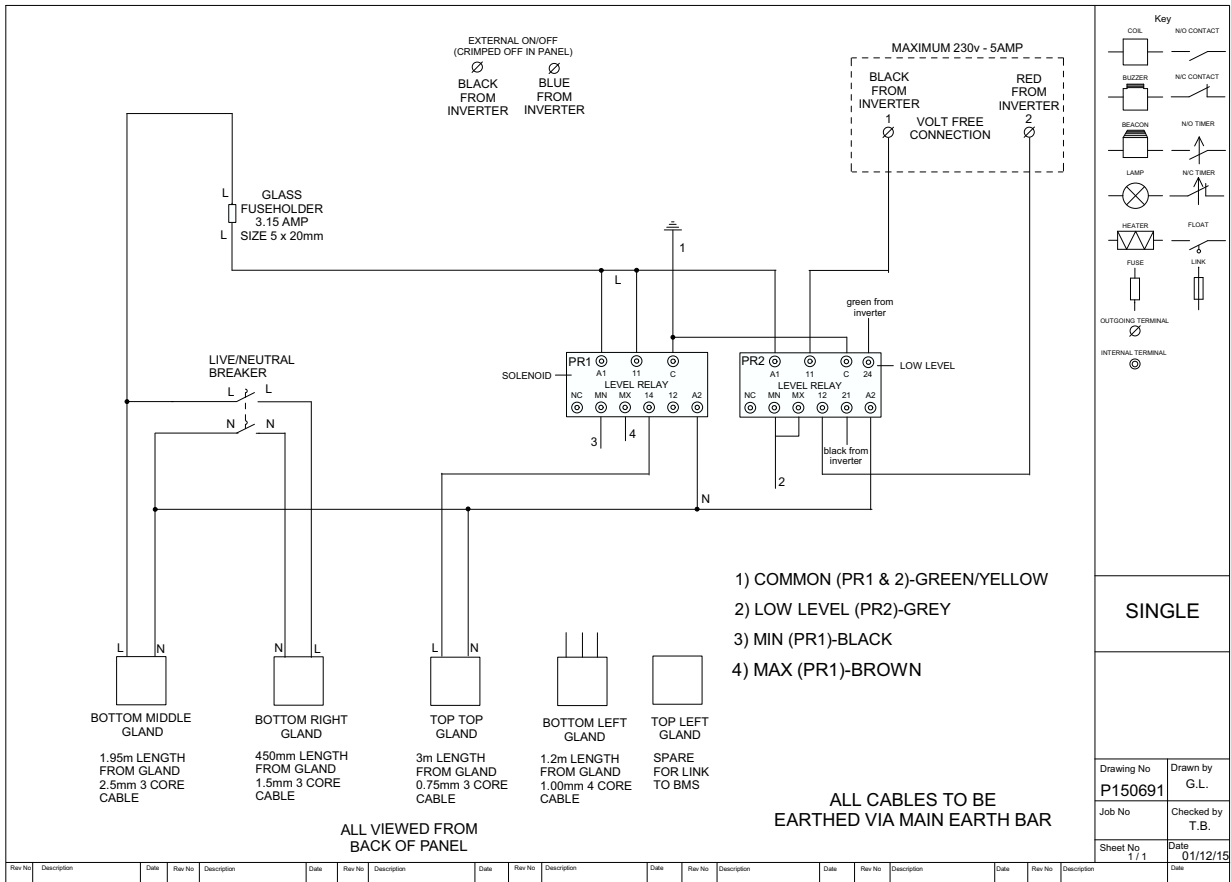
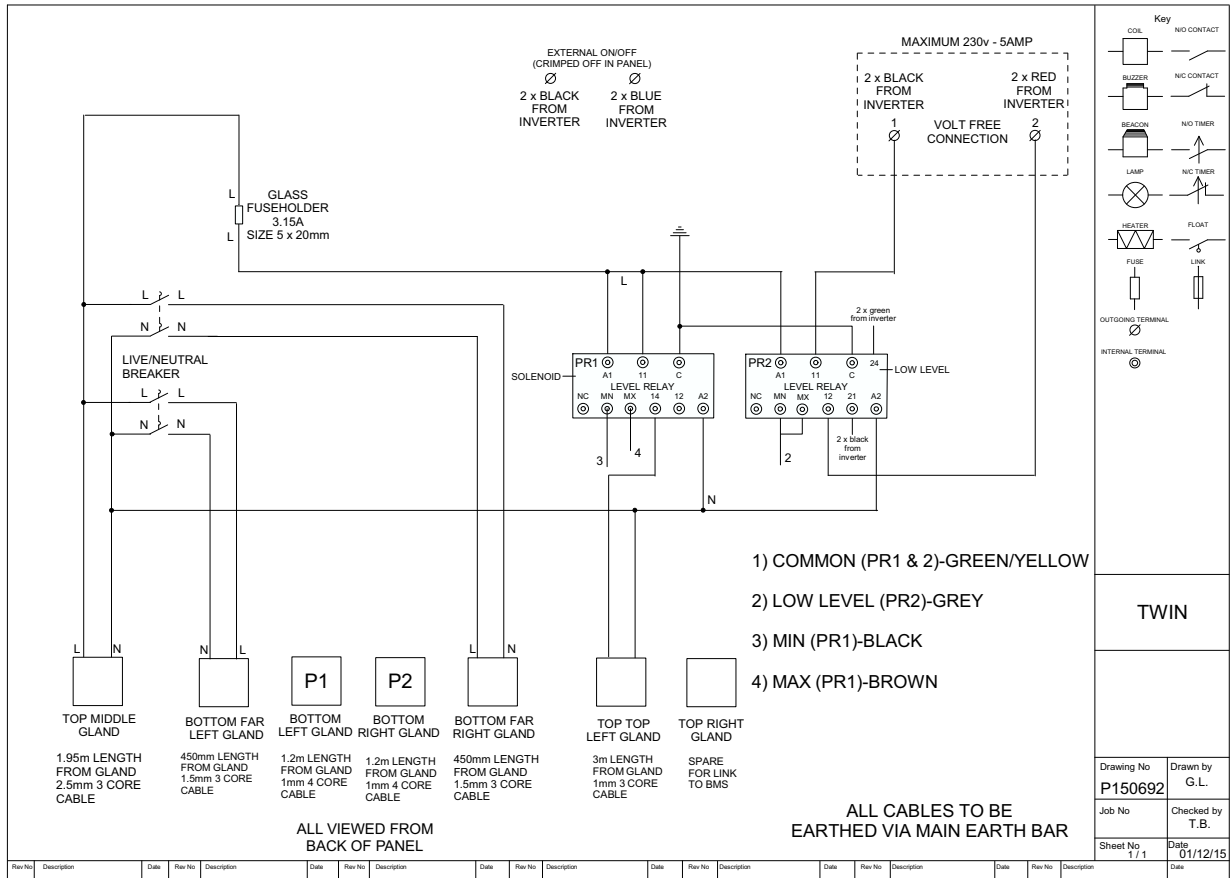

Figure 12.21: Twin Pump System Wiring Diagram (WX2 models)



# 13. VASCO V209 and V214 Pump Controllers

## 13.1 Introduction

VASCO is a variable frequency drive designed to control and protect pumping systems by varying the output frequency to the pump. VASCO can be applied to both new and existing pumping systems, and provides:

- energy and cost savings
- simplified installation and an overall lower pumping system cost
- longer life of the pumping system and relevant components
- improved reliability

VASCO, when connected to any pump, manages the system operation to maintain a certain constant physical quantity (pressure, differential pressure, flow, temperature, etc.) regardless of the conditions of use. The pump is operated only when needed thus avoiding unnecessary energy consumption.

VASCO at the same time is able to:

- protect the motor from overload and dry running
- implement soft start and soft stop to increase the system life and reduce current peaks
- provide an indication of current consumption, voltage, and power
- maintain a record of run time and display any errors and/or failures reported by the system
- control up to two additional pumps at a constant speed (Direct On Line)
- connect to other VASCO units for combined operation

Through the use of inductive filters (optional) VASCO eliminates dangerous surges that are induced in long cables, making VASCO suitable for control of submersible pumps.

## 13.2 Important Safety Information

The manufacturer strongly suggests carefully reading this operation manual before using and installing its products. Any operation (installation, maintenance and repair) must be carried out by trained, skilled, and qualified personnel. Failure to observe and follow the instructions in this manual may result in dangerous and potentially lethal electric shock. Pay attention to all standard safety and accident prevention regulations

---

### **DANGER OF ELECTRIC SHOCK**

- Disconnect VASCO from the main power supply before commencing any work.
  - Do not remove, for any reason, the cover and the cable plate without having first disconnected the device from the main power supply and having waited at least 5 minutes.
  - VASCO and pumping system must be grounded properly before operation. For the entire period VASCO is powered, high voltage is present on the output terminals of the inverter whether or not the pump is running.
  - Tightening all screws on the cover with washers is recommended before powering the device. Otherwise, there may be a failure to connect the cover to ground, creating the risk of electric shock or even death.
-



## WARNING

- The device must be connected to main power supply via a switch to ensure the complete disconnection from the network before any operation on the VASCO itself (including visual inspection) and/or on the connected load.
- Avoid any shock or significant impact during transport.
- Check the VASCO immediately upon delivery and check for damage and/or missing parts. If either occurs, immediately notify the supplier.
- Damages due to transport, incorrect installation, or improper use of the device will null and void the warranty.
- Tampering or disassembly of any component will automatically void the warranty.

**NOTE:** The manufacturer cannot be held responsible for any damages to people and/or property due to improper use of its products.

## 13.3 Technical Specifications

Model	Vin $\pm 15\%$ [V]	Max V out [V]	Max I in [A]	Max I out [A]	P2 motor power [kW]	Weight [kg]
V209	1 $\times$ 230V	1 $\times$ Vin	15	9	1.1	4
		3 $\times$ Vin		7	1.5	
V214		1 $\times$ Vin	20	9	1.1	4.3
		3 $\times$ Vin		11	3	

- Power frequency: 50-60 Hz ( $\pm 2\%$ )
- Max. ambient temperature at nominal current: 40°C (104°F)
- Max. altitude at nominal current: 1000 m
- Grade of protection: IP55
- RS485 serial communication
- auxiliary cooling fan of the VASCO, used in wall mounted applications, has a protection rating of IP54
- VASCO is able to power the motor with a higher current for a short period of time according to the linear relation: 101% of the nominal current for 10min., 110% nominal current for 1 minute.

## 13.4 Electrical Wiring

Figure 13.22: Electrical Wiring Board

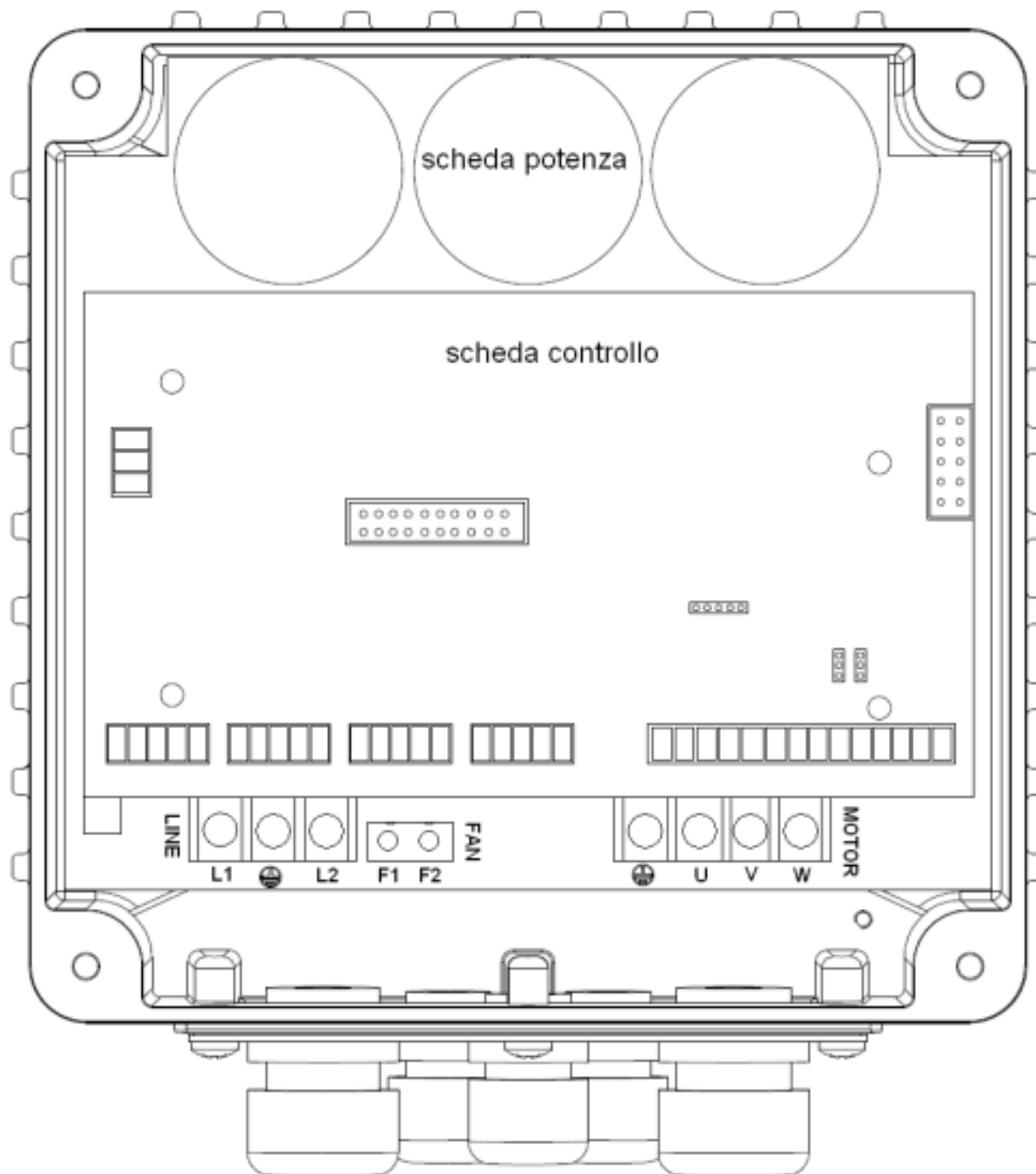

Power Supply	Output	Fans (Wall Mounted Installations)
Line: L1, L2, GND	3~ motor: GND, U, V, W 1~ motor: earth, U (running), V (common)	Fan: F1, F2
It is recommended to use cable lugs		

Figure 13.23: Recommended line and motor cables stripping

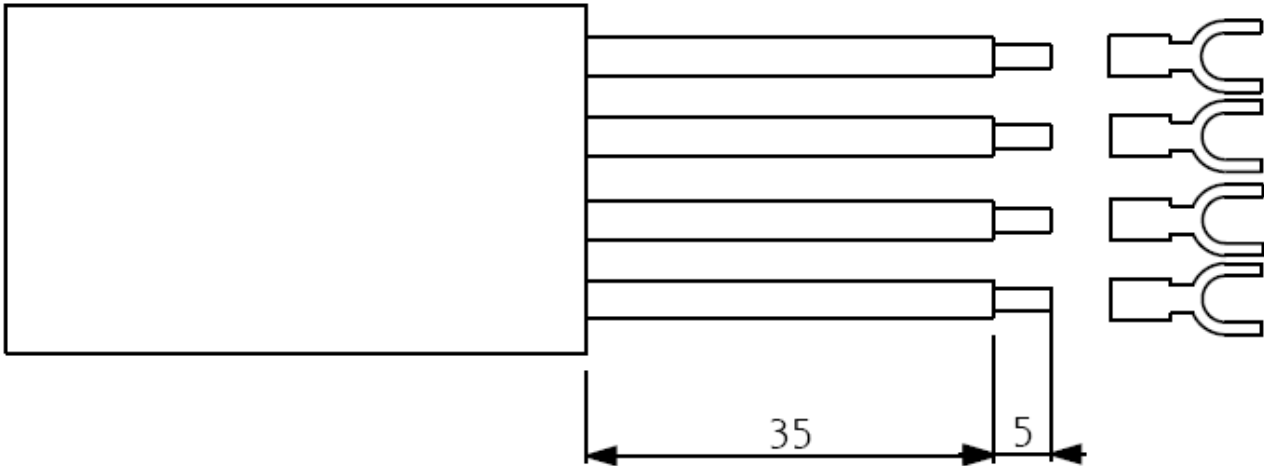
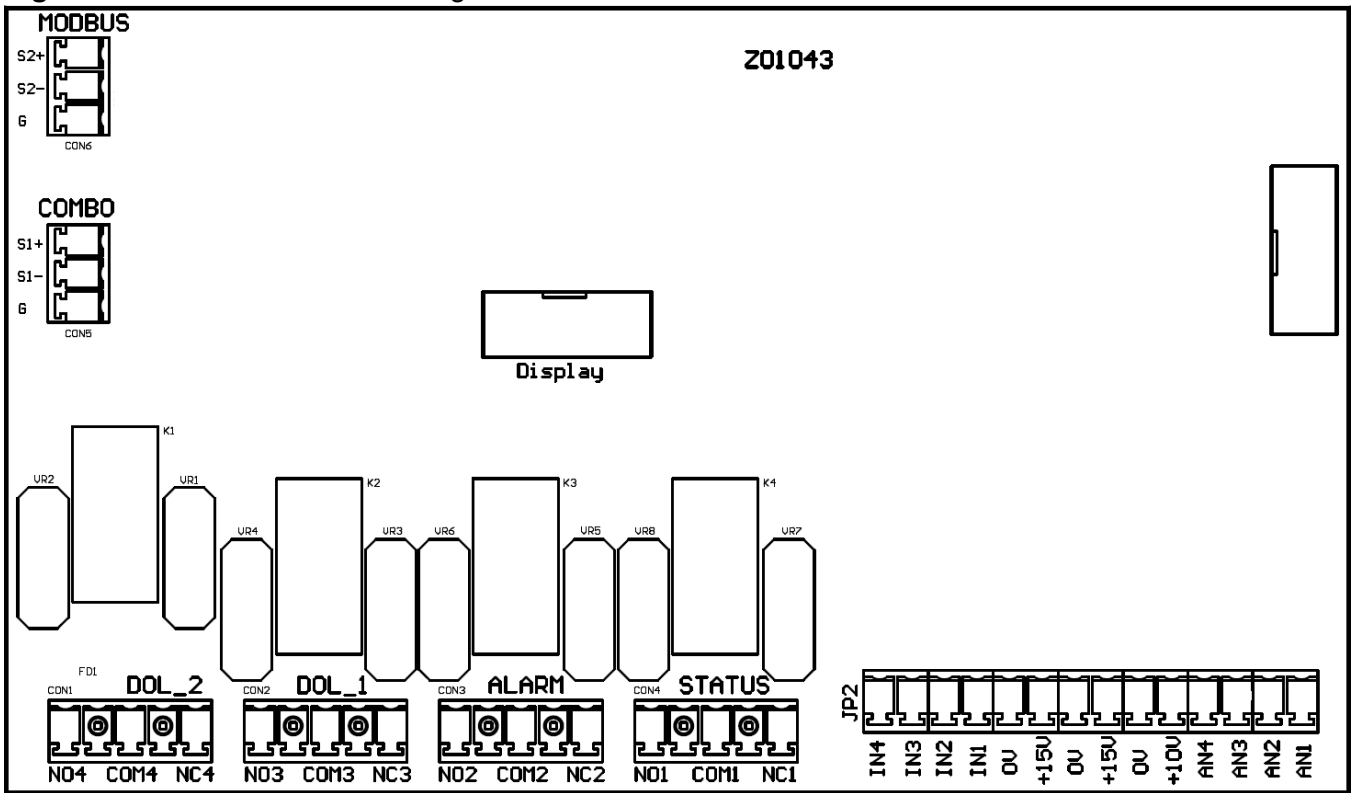

Figure 13.24: Control Board Wiring



<p>Analog inputs (10 or 15 Vdc)</p>	<ul style="list-style-type: none"> <li>• AN1: 4-20 mA: sensor 1</li> <li>• AN2: 4-20 mA: sensor 2</li> <li>• AN3: 4-20 mA / 0 - 10 Vdc (settable by jumper C.C.): external set</li> <li>• AN4: 4-20 mA / 0 - 10 Vdc (settable by C.C.): trimmer for frequency regulation / external set 2</li> </ul>
<p>Digital inputs:</p>	<ul style="list-style-type: none"> <li>• IN1: motor start &amp; stop</li> <li>• IN2: value set 1 &amp; 2 switching</li> <li>• IN3: sensor 1 &amp; 2 switching</li> <li>• IN4: motor start &amp; stop + alarms reset</li> <li>• 0V</li> </ul> <p>We recommend using only no voltage contacts. Opening or closing the digital contacts (depending on software configuration set (see IN/OUT).</p>

Digital outputs:	Motor run signal: NO1, COM1: closed contact with motor running NC1, COM1: closed contact with motor stopped
	Alarm signal: NO2, COM2: closed contact without alarm NC2, COM2: closed contact with alarm or no power supply
	DOL1 pump relay: NO3, COM3: closed contact with DOL1 running NC3, COM3: opened contact with DOL1 running
	DOL2 pump relay: NO4, COM4: closed contact with DOL2 running NC4, COM4: opened contact with DOL2 running
	Relays are no voltage contacts. Max. voltage to the contacts is 250V with maximum current of 5A.
RS485 for combo	<ul style="list-style-type: none"> <li>• S1+</li> <li>• S1-</li> <li>• G</li> </ul> <p>It is recommended to respect the polarity linking more VASCOs in series.</p>
RS485 for ModBus	<ul style="list-style-type: none"> <li>• S2+</li> <li>• S2-</li> <li>• G</li> </ul> <p>It is recommended to respect the polarity</p>

## WARNING

The protections required upstream each VASCOs depends on the type of installation, and local regulations.

- We recommend to use overload protection with the characteristic curve of type C and type B circuit breaker, sensitive to both AC and DC current (100mA sensitivity)

## 13.5 Electromagnetic Compliance

To ensure electromagnetic compatibility (EMC) of the system, it is necessary to apply the following measures:

- Always connect the device to ground.
- Use shielded signal cables by placing the screen at one end.
- Use motor cable as short as possible (<1 m / <3 ft). For longer lengths, it is recommended to use shielded cables connecting the screen at both ends
- Separate signal, motor, and power supply cables.

**NOTE:** To enable the restoration of the display screen when there are electromagnetic interference, VASCO periodically provides some fast “refresh” of the display.

## 13.6 Motor Mounted Installation

Figure 13.25: Motor Mounted Installation

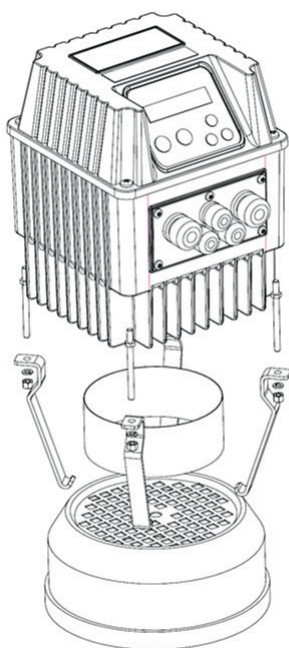

### WARNING

- Make sure the manufacturer that the electric motor is suited for operation in the inverter

In this application VASCO is cooled by the motor fan. Motor kit (available upon request) allows a solid coupling of the two units and it is composed of:

- n.°4 rods
- n.°4 M5 nuts
- n.° 4 hooks
- n.° 1 cooling ring

**NOTE:** Make sure to remove the auxiliary cooling fan if VASCO is coupled to a motor. Failure to do so creates a high risk of overheating the motor and VASCO unit.

## 13.7 Remote/Wall Mounted Installation

Figure 13.26: VASCO Remote/Wall Mounted Installation

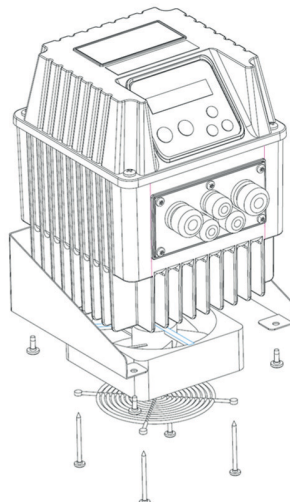

**NOTE:** Make sure to properly attach the grid of the auxiliary cooling fan

In this application VASCO is cooled independently by its auxiliary cooling fan integrated in the radiator. The wall mounting kit is comprised of:

- n.° 1 auxiliary fan 230V AC (VASCO 209,214)
- n.° 4 screws to fix cooling fan
- n.° 1 protection grill
- n.° 1 metal bracket in AISI 304
- n.° 4 screws to fix VASCO to wall bracket

## 13.8 Operation and Programming

Setting Parameters are organized in 2 levels:

- 1) Installer level (MENU' CONTROL PARAMETERS, MENU' IN/OUT PARAMETERS, MENU' CONNECTIVITY PARAM.) A password is required for this level (default 001)
- 2) Advanced level (MENU' MOTOR PARAMETERS). A password is required for this level (default 002)

Installer and Advanced levels can be entered only with the correct password; otherwise, it is impossible to set up and/or modify any parameters (they can be only displayed).

The display screen on the VASCO is a back-lit LCD displaying 2 rows of 16 digits each. Alarms are indicated by an audible signal.

**Figure 13.27:** VASCO Control Panel

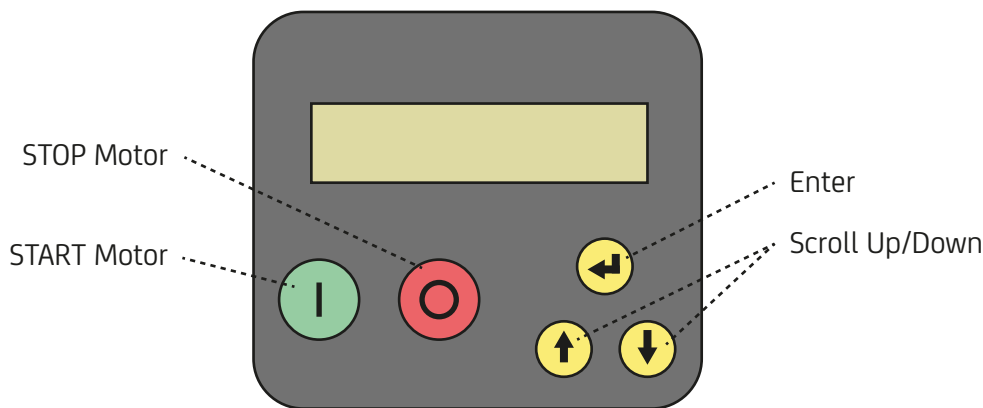

**Figure 13.28:** Display shown when first powering VASCO



**NOTE:** One pump/VASCO combination will have been set as master (display name 00) and others as slaves (e.g. display name 01). The term "INV:" will be replaced by the appropriate display name, "00:" or "01:" etc. Various messages are then displayed.

The first row of the display gives the pump status as follows:

- Inv: ON XXX.X Hz - VASCO is powered and is powering the motor, showing its frequency
- Inv: ON Mot: OFF - VASCO is powered but motor is not running (i.e. motor/pump was stopped due to minimum frequency being reached).
- Inv: OFF Mot: OFF - VASCO is not powered.

The following end user messages are displayed on the second row by pushing the scroll buttons:

**Table 13.14:** VASCO End User Messages

Inv: ON/OFF Mot: ON/OFF p = XX.X [bar]	p is the pressure value read by the pressure transducer. By pressing ENTER the pressure set vale is displayed
--	---

Inv: ON/OFF Mot: ON/OFF f = XXX [Hz]	f value is the supply frequency to the motor. On fox frequency control mode, by pressing ENTER you can change the f value manually (word "set" is displayed), press ENTER again to exit parameter setting (word "set" disappears).
Inv: ON/OFF Mot: ON/OFF Vin = XX.X [V] I=XX.X	Vin is the line voltage. This value is displayed only if motor is OFF. If motor is NO, A value equal to the absorbed motor current.
Inv: ON/OFF Mot: ON/OFF cosphi = XXX	cosphi index means the angle phi between the voltage and current absorbed by the motor
Inv: ON/OFF Mot: ON/OFF P = XXXXX [W]	P is the power in Watts supplied to the pump
Inv: ON/OFF Mot: ON/OFF STATUS: NORMAL	NORMAL status means no alarms. If an alarm occurs, a message blinks on the display and an audible signal is activated. Pressing ENTER accesses: VASCO lifetime, PUMP lifetime, consumption statistic, alarm list. To return to previous views, press ENTER.
Inverter Life xxxxx h : xx m	
Motor Life p = XX.X [bar]	
%f 25 50 75 100 %h XX XX XX XX	
XXXXXXXXXXXXXXXXXX XXXXXXXXXX h : XX m	

### **WARNING: ADVANCED PARAMETERS. IMPROPER SETTINGS CAN COMPROMISE THE INTEGRITY AND LIFE OF THE CONTROLLER AND PUMP**

- You should only access and adjust parameters if you are trained to do so
- For further assistance, call the Dutypoint Technical Service line of 01452 300590.

Pressing ENTER when you are in the initial display will show the following menus:

**Table 13.15:** VASCO Menus

MENU' Motor param.	Installer password required to enter level 1 (default 001)
MENU' Control. param.	Advanced password required to enter level 2 (default 002)
MENU' IN/OUT. param.	Installer password required to enter level 1 (default 001)
MENU' Connect. param.	Installer password required to enter level 2 (default 001)
MENU' Change init.set. param.	Advanced password required to enter level 2 (default 002)

To exit the Menu level and return to the initial display, press STOP button.

**Table 13.16:** Initial Configuration

When VASCO is switched on for the first time, the initial setting menu is displayed for the initial setting of parameters to configure pump characteristics, pressure sensor range, and system characteristics. If the initial setting procedure is

not completed properly, it is impossible to run the pump. Initial setting procedure can be repeated if necessary. The initial setting procedure can be repeated (by using the 2rd level password) to reconfigure VASCO or if VASCO is installed in a different system. A brief description of parameters and their allowable ranges are listed below

Parameter	Default	Description
Language XXXXXXXX	XXXX	End user communication language
Unit XXXXXXXX	bar	Unit
Motor Type Single/three phase	Three phase	Type of motor connected
Rated Motor Amp. I = XX.X [A]	XX	Rated current of the motor as per its nameplate indication increased by 10%. The voltage drop caused by the inverter leads to higher input current than nominal. Make sure the motor is capable of accepting the increased current.
Rated Motor Freq f = XXX [Hz]	50	Rated frequency of the motor as per its nameplate.

## 13.9 Control Modes

Mode Name	Description	Abbreviation
Constant value (default)	VASCO changes the pump speed to keep the set value constant regardless water demand	CV
Fix speed	VASCO feeds the pump at set frequency, so the pump speed is kept constant	FS
Const. value 2 set	the two values are selected by opening or closing the digital input IN2	CV2
Fix speed 2 value	Fix speed 2 val: the two values are selected by opening or closing the digital input IN2	FS2
External speed	control motor frequency by using analogical input AN4	ES

## 13.10 Parameters

**Table 13.17:** Control Parameters

Parameter	Default	Description	Control Mode				
			C V	F S	CV 2	FS2	E S
Max alarm value XXX.X [bar]	10	Maximum value allowed in the system. If the readen value goes over this value, an alarm occurs and the pump is stopped. Pump is automatically restarted if the readen value goes below the maximum value for a period of at least 5 seconds.	•	•	•	•	•
Min alarm value XXX.X [bar]	0	Minimum value allowed in the system. If the readen value goes lower than this value, an alarm occurs and the pump is stopped. Pump is automatically restarted if the readen value goes higher than the minimum value for a period of at least 5 seconds.	•	•	•	•	•



Parameter	Default	Description	Control Mode				
			C V	F S	CV 2	FS2	E S
Ext. set enabling ON/OFF	OFF	Enabling of set value changing by analogue input AN3.	•		•		
Set value XXX.X [bar]	3	Set value to be kept constant	•				
Compensation XXX.X [bar]	0	Value compensation at the maximum frequency for each pump. Acting on the green button you can reverse the sign	•				
Set value 2 XXX.X [bar]	3	Set value to be kept constant			•		
Compensation 2 XXX.X [bar]	0	Value compensation at the maximum frequency for each pump. Acting on the green button you can reverse the sign			•		
Set value update XX [s]	5	Time to update set value for compensation.	•		•		
Operating freq. XXX [Hz}	50	Frequency value to feed the pump.		•			
Operating freq 2 XXX [Hz}	50	Frequency value to feed the pump.				•	
Freq min control XXX [Hz}	50	Minimum frequency below which the pump tries to stop	•		•		•
Stop delay XX [s]	5	Delay for which the pump tries to stop below freq.min.control	•		•		•
Control ramp XXX.X [s]	20	Ramp time from freq.min.control to min.motor freq. If, during this time, the read value goes below the (set value - delta control), VASCO powers the motor again; otherwise, VASCO will stop the pump	•		•		•
Delta control XXX.X [bar]	0.1	Value drop below the set value required to restart the pump during control ramp	•		•		
Delta start XXX.X [bar]	0.5	Value drop below the set value required to start the pump from stop condition	•		•		
Delta stop XXX.X [bar]	0.5	Value increase respect to set value which must be passed so that there is a forced shutdown of the pump	•		•		
Ki		Kp and Ki parameters allow the dynamic control of system by VASCO; set values (Ki=50, Kp=005) are usually enough to get a valid dynamic control.	•		•		
Kp							
Pump DOL 1 ON/OFF	OFF	Function to activate (ON) the first auxiliary pump DOL 1 (Direct On Line pump)	•		•		
Pump DOL 2 ON/OFF	OFF	Function to activate (ON) the second auxiliary pump DOL 2 (Direct On Line pump).	•		•		
COMBO ON/OFF	OFF	Enabling or disabling COMBO operation as described in COMBO chapter	•		•		

Parameter	Default	Description	Control Mode				
			C V	F S	CV 2	FS2	E S
Address XX	00	VASCO address: • 00 master • 01 to 07 slaves	•		•		
Alternance ON/OFF	OFF	Function to allow alternating between the VASCOs connected in COMBO (or pumps connected in DOL) in order to allow equal use of each pump in the group; master will reorganize the starting priority of the pumps by checking the life of each of them	•		•		
Alternance period. ON/OFF	0	Maximum difference in terms of hours between VASCOs in the group. 0 stays for 5 minutes	•		•		
Start delay AUX. t = XX [s]	0	Delay time with which the slaves start after the variable speed pump has reached the maximum frequency and the pressure value has fallen below set value – delta control	•		•		
PI control. Direct/Reverse	Direct	Direct: increasing motor speed also measured value increases Reverse: increasing motor speed, measured value decreases.	•		•		
Periodic autorun t = XX [s]	0	Pump periodic autorun after XX hours of inactivity. Value 0 makes function disabled. Warning, review the advice in chapter 1	•	•	•	•	•
Dry run cosphi X.XX	0.65	Cosphi value below which the unit stops the motor and give “no water” alarm	•	•	•	•	•
Restarts delay XX [min]	10	Restart delay after a dry running alarm. At each tentative (max 5) restart delay will be doubled	•	•	•	•	•

**Table 13.18:** Motor Parameters

Parameters	Default	Description
Rated motor Volt. XXX [V]	XXX	Motor rated voltage (as shown on motor nameplate).
Voltage boost XX.X [%]	0%	Voltage increase during the motor start up. Warning: An excessive value can seriously damage the motor. Contact the motor manufacturer for further information
Rated motor amp. XX.X [A]	XX	Rated motor current as per its nameplate indication increased by 5%.
Rated motor freq XXX [Hz]	50	Rated motor frequency as per its nameplate
Max motor freq. XXX [Hz]	50	Maximum motor frequency. Note: by reducing the maximum motor frequency, maximum current will be reduced as well
Min motor freq. XXX [Hz]	20	Minimum motor frequency

Parameters	Default	Description
Ramp up time XXX.X [sec]	4	Ramp-up time to reach the speed required to achieve the set pressure (or frequency value). Longer times delay the system reaching the preset value but better protect system components. Excessively long ramp-up times can create difficulties in VASCO setup, and can also cause false overload alarms.
Ramp down time XXX.X [sec]	4	Ramp-down time to reach zero speed. Longer times keep the system pressurized, while protecting the system components. Excessively long ramp-down times can create difficulties in VASCO setup. Excessively short ramp-down times can cause false overload alarms
Ramp f min mot. XXX.X [sec]	1.5	Time to reach the minimum motor frequency and vice versa
PWNM XX.X [kHz]	8	Carrier frequency (switching frequency). It is possible to choose PWM in the range of 2.5, 4, 6, 8, 10 kHz Higher values give a more sinusoidal wave with fewer losses for the motor but higher losses for the inverter (increased inverter heating). If long cables are used (>20 m / >76 ft) (submersible pump) it is recommended to install an inductive filter between VASCO and the motor (available upon request) and to set the value of PWM to 2.5 kHz. This reduces the risk of voltage spikes, which can damage motor and cable insulation.
F/f lin --> quad. XXX [%]	85%	V / f characteristic with which VASCO feeds the engine. The linear characteristic corresponds to constant torque with variable speed. The quadratic characteristic is normally used with centrifugal pumps. The selection of torque characteristic should be done ensuring a smooth operation, a reduction of energy consumption and a lower level of heat and acoustic noise.
Rotation sense --> / <--	-->	If, during the test, the motor runs in reverse, it is possible to change the wiring sequence via software without physically changing wires at the terminals.
Autorestart ON/OFF	OFF	If ON is selected, after a lack of voltage, VASCO returns to its normal status; if VASCO was powering the pump before the voltage drop, it resumes powering the pump automatically. Warning: review the safety information earlier in this chapter.

Table 13.19: IN/OUT Parameters

Parameter	Default	Description
Unit XXXXX	bar	Unit [bar,%,ft,in,cm,m,K,F,C,gpm,l/min,m3/h,atm,psi]
F. scale sensor XXX.X	16	Sensor full scale
Min value sensor XXX.X	0	Sensor minimum value
Offset input 1 [%]	20%	Zero correction for analogue input 1 (4-20 mA) (20mA × 20% = 4mA)
Offset input 2 [%]	20%	Zero correction for analogue input 2 (4-20 mA) (20mA × 20% = 4mA)
Offset input 3 [%]	0%	Zero correction for analogue input 3 (4-20 mA) (20mA × 20% = 4mA)
Offset input 4 [%]	0%	Zero correction for analogue input 4 (4-20 mA) (20mA × 20% = 4mA)

Parameter	Default	Description
AN1,AN2 function XXXXXX	Independent	Function logic for analogue input AN1,AN2 (independent, lower value, higher value, difference 1-2)
Digital input 1 N.O./N.C.	N.O.	By selecting N.O. (normally open) VASCO runs the motor if the digital input 1 is open; motor will be stopped if the digital input 1 is closed By selecting N.C. (normally closed) VASCO runs the motor if the digital input 1 is closed; motor will be stopped if the digital input 1 is opened
Digital input 2 N.O./N.C.	N.O.	By selecting N.O. (normally open) VASCO runs the motor if the digital input 2 is open; motor will be stopped if the digital input 1 is closed By selecting N.C. (normally closed) VASCO runs the motor if the digital input 2 is closed; motor will be stopped if the digital input 1 is opened
Digital input 3 N.O./N.C.	N.O.	By selecting N.O. (normally open) VASCO runs the motor if the digital input 3 is open; motor will be stopped if the digital input 1 is closed By selecting N.C. (normally closed) VASCO runs the motor if the digital input 3 is closed; motor will be stopped if the digital input 1 is opened
Digital input 4 N.O./N.C.	N.O.	By selecting N.O. (normally open) VASCO runs the motor if the digital input 4 is open; motor will be stopped if the digital input 1 is closed By selecting N.C. (normally closed) VASCO runs the motor if the digital input 4 is closed; motor will be stopped if the digital input 1 is opened
Dig.In2/3 delay [s]	3	Digital input IN2 & IN3 delay Digital input IN1 has 1 second fix delay

**Table 13.20:** Connectivity Parameters

Parameters	Default	Description
MODBUS address XXX	1	MODBUS address from 1 to 247
MODBUS baudrate XXXXX [bps]	9600	MODBUS baudrate from 1200 bps to 57600 bps
MODBUS data format XXXXX	RTU N81	MODBUS data format: RTU N81, RTU N82, RTU E81, ETU O81

## 13.11 Protections and Alarms

Any time a protection occurs a blinking message is displayed together with an audible alarm; on STATUS in the initial view, the protection is displayed; by pressing the STOP button. Only from this position (STATUS) in the initial view is it possible to try to reset the alarm; if VASCO does not reset the alarm it is displayed again together an audible sound.

Alarm Message	Alarm Description	Possible Solutions
OVERCURRENT MOT.	Motor overload: input current of the motor is higher than the rated motor current setting parameter. Motor voltage drop caused by the inverter causes the motor input current to be higher than rated. Contact motor manufacturer to check if motor is capable of accepting this current	<ul style="list-style-type: none"> <li>Make sure that the motor current setting parameter is higher than rated</li> <li>Check other possible causes of over current</li> </ul>
UNDER VOLTAGE	Supply voltage too low	Check possible causes of undervoltage

Alarm Message	Alarm Description	Possible Solutions
OVER VOLTAGE	Supply voltage too high	Check possible causes of overvoltage
OVER TEMP. INV.	Inverter over temperature	<ul style="list-style-type: none"> <li>• Make sure than ambient temperature is less than 40 °C (104 °F).</li> <li>• Check if auxiliary cooling fan is working properly and if mounting space is adequate for proper cooling</li> <li>• Reduce the PWM value (Advance Parameter Menu)</li> </ul>
NO LOAD	No load	Check if load is properly connected to the VASCO terminals
NO WATER (DRY RUN COSPHI)	Motor cosphi is lower than the set value of dry running cosphi	<ul style="list-style-type: none"> <li>• Check that the pump is primed</li> <li>• Check the set value of dry running cosphi. Dry running cosphi is approximately 60% of the rated cosphi (at rated frequency) listed on the motor plate</li> </ul> <p>If pump's cosphi is lower than the set dry-running cosphi for at least 2 seconds, VASCO stops the pump. VASCO tries to run the pump every 10, 20, 40, 80, 160 minutes and then the pump is stopped</p> <p>WARNING: if dry running protection occurs, VASCO will try to start the pump automatically. Be sure to cut power supply to VASCO before performing any maintenance.</p>
SENSOR FAULT	Sensor error	<ul style="list-style-type: none"> <li>• Check the transducer</li> <li>• Check the wiring of the transducer</li> </ul>
MAX. VALUE ALARM	Measured value has reached the maximum value accepted by the system	<ul style="list-style-type: none"> <li>• Check possible causes of reaching max value</li> <li>• Check the max alarm value setting</li> </ul>
MIN. VALUE ALARM	Measured value has reached the lowest value accepted by the system	<ul style="list-style-type: none"> <li>• Check possible causes reaching min value (i.e. broken pipe, open pressure relief valve, etc.)</li> <li>• Check the min alarm value setting</li> </ul>
IGBT TRIP ALARM	The current drawn by the load exceeds the capacity of VASCO. VASCO is still able to continue to power the load for 10 minutes with an output current of 101% of nominal and for 1 minute with an output current of 110% of nominal	<ul style="list-style-type: none"> <li>• Increase the ramp-up time</li> <li>• Make sure that the load current is at least 10% below the VASCO nominal current</li> <li>• Check the voltage drop along the supply cable to the motor</li> </ul>
NO COMMUNICATION	Communication between Master and slave(s) has been interrupted	<ul style="list-style-type: none"> <li>• Check the wiring connections</li> <li>• Make sure the Master is not in the Menu level; if so, exit from the level</li> <li>• In the STATUS of the slave (where the alarm is displayed) try to reset the alarm by pushing STOP button</li> </ul>
ADDRESS ERROR	Same address as other VASCOs in the group	The address of each VASCO needs to be different
KEYBOARD FAULT	A Button on the keyboard has been pressed for more than 150 seconds	<ul style="list-style-type: none"> <li>• Make sure buttons are not depressed</li> <li>• Call service assistance</li> </ul>

Alarm Message	Alarm Description	Possible Solutions
ACTIVE DIG.IN.X	Digital input X opened /closed	Check the input digital configuration (IN/OUT Parameters menu)
ALARM SLAVE XX	slave XX error detected by master	Check the status of the slave

## 13.12 Dry Running

### DANGER

If dry running protection occurs, VASCO will attempt to start the pump automatically.

- Be sure to cut power before attempting maintenance

**NOTE:** If the pump's cosphi is lower than the dry-running cosphi for at least 2 seconds, VASCO will stop the pump. VASCO will try to run the pump every 10, 20, 40, 80, 160 minutes and then the pump is stopped

VASCO will stop the pump if the input motor current is higher than the set motor current for an extended time. By pressing the START button it is possible to run the pump again.

VASCO will stop the pump if the input voltage is higher than the set voltage for an extended time. By pressing the START button it is possible to run the pump again. VASCO will stop the pump if the input voltage is lower than the set voltage for an extended time. By pressing the START button it is possible to run the pump again.

## 13.13 COMBO Function (Systems with multiple pumps)

In the "Control parameters" menu it is possible to enable the COMBO function that allows serial communication between up to 8 VASCOS, each one connected to a pump.

To achieve the COMBO function in a system consisting of several interconnected VASCOS, a pressure sensor is connected to each VASCO. The value of the set pressure is communicated to the slaves via the serial port

**Figure 13.29:** RS485 Serial Communication

VASCO's communication is made through a private protocol using the RS485 port. Each VASCO must be connected to each other by using a tripolar cable (0.5 mm<sup>2</sup>) wired on S+,S-,G pins on control board.

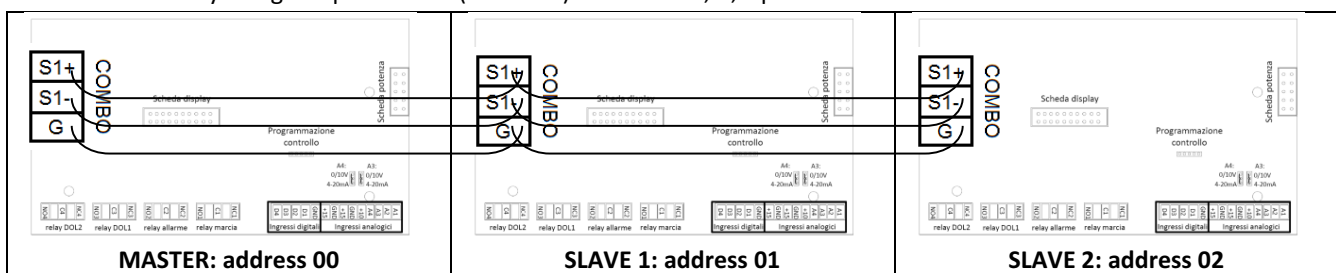

## 13.14 Master Setup

- 1) Supply power to the VASCO inverter
- 2) If not yet completed, perform the initial configuration - see [Table 13.16: Initial Configuration](#) (p. 57)
- 3) Initial view is shown:

```
Inv: ON/OFF Mot: ON/OFF
p_mis=XX.X [bar]
```

- 4) Scroll until:

```
Menu
ENT to access
```

5) Press ENT:

Menu Control param.
------------------------

6) Press ENT

7) Insert password (default 001).

8) Scroll until:

COMBO ON/OFF
-----------------

9) Set ON

10) Set:

Address xx	00	VASCO's address in parallel operation • 00: VASCO master
Alternance ON/OFF	OF F	Function to allow alternating between the VASCOs connected in parallel in order to allow equal use of each pump in the group; in this way Master will reorganize the starting priority of the pumps by checking the life of each of them.
Start delay AUX t = XX [s]	0	Delay time with which the slaves start after the variable speed pump has reached the maximum frequency and the pressure value has fallen below set value – delta control.

11) Press STOP (red button)

12) Press STOP again

## 13.15 Slave Setup

Follow master setup until point [11](#).

**NOTE:** In case of failure of master in a Combo system, will be replaced by slave. As a consequence, all parameters must be setup independently on each inverter, master mode.

In case of alarm or failure of a pump in a Combo system, this pump's operation will be replaced (temporary or permanently) by another pump.

In case of failure of master in a Combo system, it will be replaced by the next slave after about 1 minute. In order to enable master replacement Autorestart must be set ON in each slaves

## 13.16 Troubleshooting

Problem	Suggested Actions
LCD does not switch on after powering the VASCO	<ul style="list-style-type: none"> <li>• Check the connecting flat cable between the LCD board (attached to the cover) and the control board</li> <li>• Check the fuses</li> <li>• Check that the power cables are properly connected</li> </ul>

Problem	Suggested Actions
Power line of VASCO is interrupted by the differential protection contactor	<ul style="list-style-type: none"> <li>• Check the leakage current to ground of EMC filter</li> <li>• Following a rapid off/on the power supply, the differential contact can interrupt the power. After turning off the VASCO it is recommended to wait at least 1 minute before restarting</li> </ul>
When performing sensor test operation, SENSOR OFF alarm occurs	<ul style="list-style-type: none"> <li>• Check that the sensor cable is properly connected to the sensor device and to the VASCO</li> <li>• Make sure that the sensor and its cable are not damaged</li> <li>• Check that the operating range of sensor is of 4-20 mA type and the value of 15 V is within the voltage feed range of the sensor</li> </ul>
Frequency and pressure oscillation on constant pressure control mode	<ul style="list-style-type: none"> <li>• Check if the water tank and its air pressure are correctly set. It may be necessary to increase the tank volume or reduce the pre-charge pressure.</li> <li>• Check the ki &amp; kp parameters (Control parameters menu). At first, it is suggestible to increase the Ki value. If it not enough reduce of one unit the Kp value</li> </ul>
Measured pressure drops too much before VASCO starts the pump.	<ul style="list-style-type: none"> <li>• Decrease the delta start value (Control Parameters menu)</li> <li>• Check to see if the water tank and it's air pressure are correctly set. It may be necessary to increase the tank volume or reduce the pre-charge pressure</li> <li>• Modify the value of ki &amp; kp parameters (Control Parameters menu). At first, it is suggestible to reduce the Ki value. If it is not enough increase of one unit the Kp value</li> </ul>





# 14. EC Declaration of Conformity

We: Dutypoint Limited

Of: Shepherd Road, Gloucester, GL2 5EL, United Kingdom

In accordance with the following directives:

- 2006/42/EC: Machinery Directive
- 2004/108/EC: Electromagnetic Compatibility Directive

Hereby declare that the equipment:

Description	Dutypoint Cold Water Booster Set
Product Range	ScubaTANK WXx-xxxx-xxxx

Is in conformity with the applicable requirements of the following documents:

- EN 809:1998+A1:2009: Pumps and pump units for liquids - Common safety requirements
- EN 60204-1:2006: Safety of machinery - Electrical equipment of machines - Part 1: General requirements
- EN ISO 12100:2010: Safety of machinery - General principles for design
- EN 61000-6-2:2005: Electromagnetic compatibility (EMC) — Part 6-2: Generic standards
- EN 61000-6-4:2007: Electromagnetic compatibility (EMC) — Part 6-4: Generic standards

I hereby declare that the equipment described above has been designed to comply with the relevant sections of the above referenced specifications. The unit complies with all applicable essential requirements of the directives.



Russell Freeman, Director

# 15. Dutypoint Standard Warranty

Your Dutypoint Systems standard product warranty is valid for a period of 12 months from date of delivery. The full terms and conditions are on the reverse of this certificate.

If you need to contact us regarding your warranty or any issue regarding your Dutypoint product, please contact our service department:

- Tel: +44(0)1452300590
- Email: [service@dutypoint.com](mailto:service@dutypoint.com)

Once your standard product warranty has expired, you may wish to take out our infinity service contract for an extended amount of cover. For more information visit our website: [www.dutypoint.com/infinity](http://www.dutypoint.com/infinity)

## 15.1 Terms and Conditions

- 1) The Company warrants that on delivery, and for a period of 12 months from the date of delivery, or such longer period as agreed by the Company in writing, (Warranty Period), the Goods shall:
  - a) conform in all material respects with their description as set out in the Agreement;
  - b) be free from material defects in design, material and workmanship; and
  - c) be of satisfactory quality (within the meaning of the Sale of Goods Act 1979).
- 2) Subject to Clause 3, if:
  - a) the Customer gives notice in writing to the Company during the Warranty Period within a reasonable time of discovery that some or all of the Goods do not comply with the warranty set out in Clause 1; and
  - b) the Company is given a reasonable opportunity to examine such Goods; and
  - c) the Customer (if asked to do so by the Company) returns such Goods to the Company's place of business, the Company shall, at its option, repair or replace the defective Goods, or refund the price of the defective Goods in full.
- 3) The Company shall not be liable for the failure of the Goods to comply with the warranty set out in Clause 1 in any of the following events:
  - a) the Customer makes any further use of such Goods after giving notice in accordance with Clause 2;
  - b) the defect arises because the Customer failed to follow the Company's oral or written instructions as to the storage, commissioning, installation, use and maintenance of the Goods or (if there are none) good trade practice regarding the same;
  - c) the defect arises as a result of the Company following any drawing, design or Specification supplied by the Customer;
  - d) the Customer alters or repairs such Goods without the written consent of the Company;
  - e) the defect arises as a result of fair wear and tear, wilful damage, negligence, or abnormal storage or working conditions; or
  - f) the defect arises as a result of the Customer's negligence or the Customer's breach of the Agreement.
- 4) Clause is the Customer's sole remedy in respect of the matters described therein.
- 5) The terms implied by sections 13 to 15 of the Sale of Goods Act 1979 are, to the fullest extent permitted by law, excluded from the Agreement.
- 6) The terms and conditions of the Agreement apply to any repaired or replacement Goods supplied by the Company.

# DUTYPOINT

SETTING  
THE BAR

Dutypoint Limited  
Shepherd Road  
Gloucester  
GL2 5EL  
United Kingdom

**T:** +44(0)1452 300592  
**W:** [www.dutypoint.com](http://www.dutypoint.com)