

Notes:-  
1. This document is for information/quote purposes and NOT to be used for design purposes

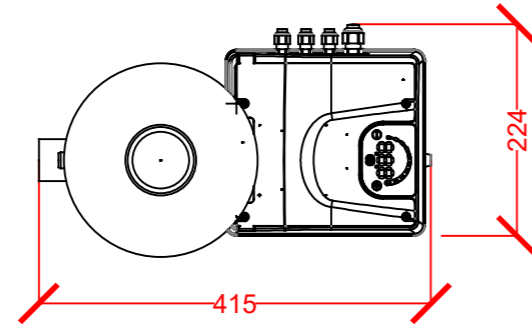

PLAN VIEW

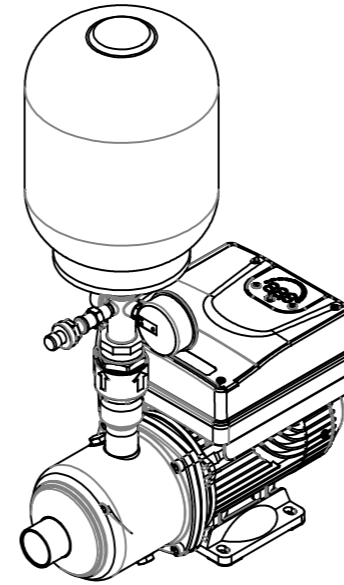

ISOMETRIC VIEW

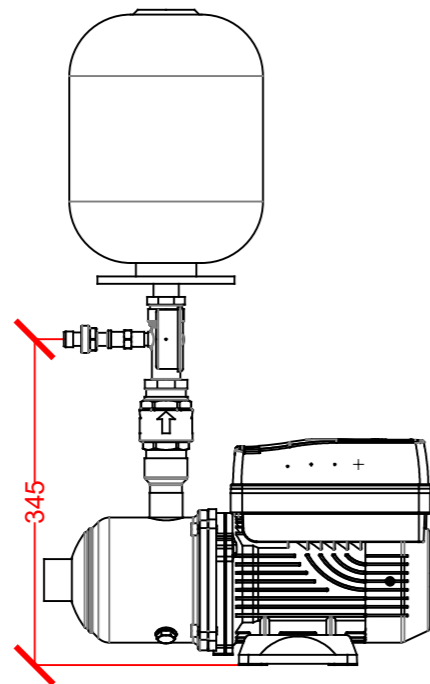

SIDE VIEW

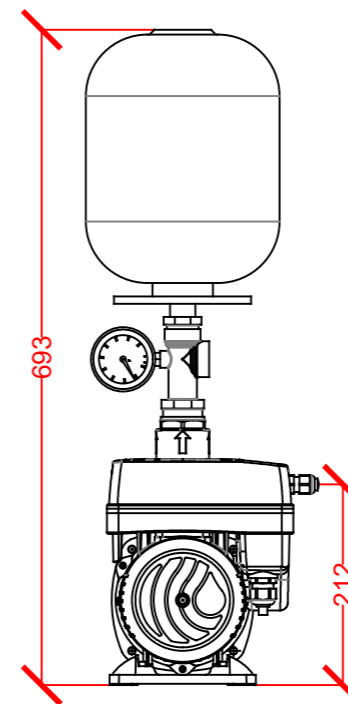

FRONT VIEW

**QUOTE DRAWING**

**DUTYPOINT** 

PUMPS | SYSTEMS | SERVICING | KNOW-HOW

Shepherd Road  
Gloucester  
GL2 5EL  
T: 01452 300 110

This drawing is the property of DUTYPOINT. Copyright is reserved by them and the drawing issued on the condition that it must not be used for any purpose other than that for which it is supplied and not to be copied, reproduced, retained or disclosed to any unauthorised person either wholly or in part without the consent in writing of DUTYPOINT

Scale: 1:8      Date: 15/03/2018      Drawn: GDS

Title: **VG1-5HME04-LSM**

Drawing Number: **VG1-5HME04-LSM**

Internal Ref: **VG Products**

Client: **X**