

REVISION HISTORY			
REV	DESCRIPTION	DATE	APPROVED

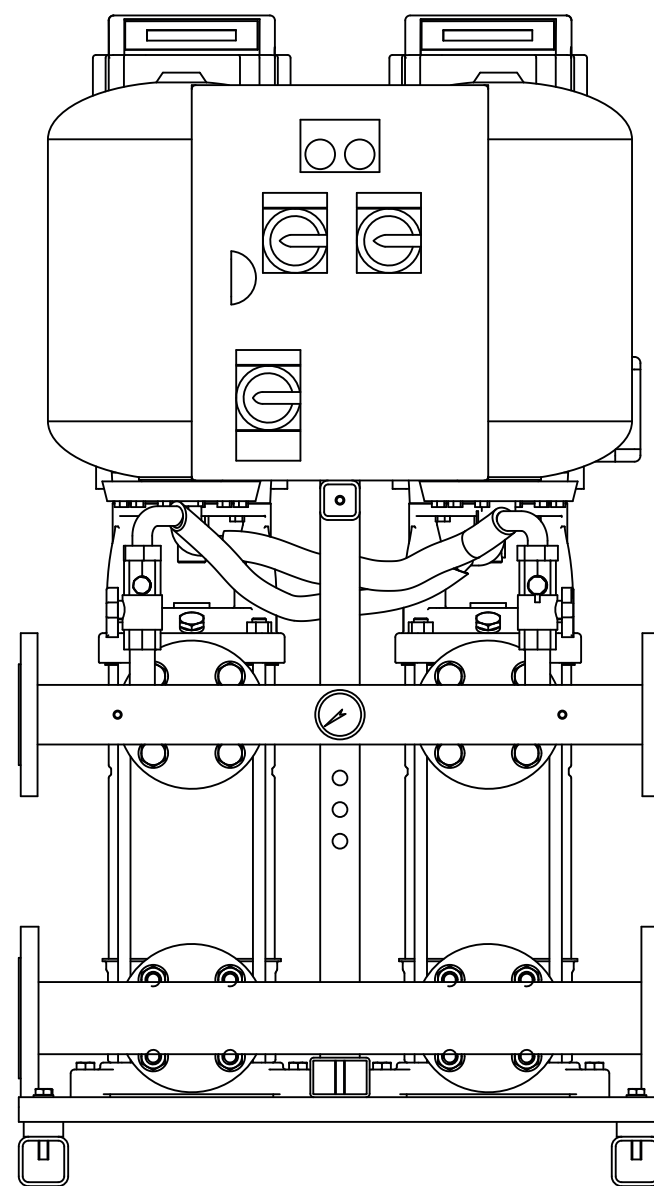
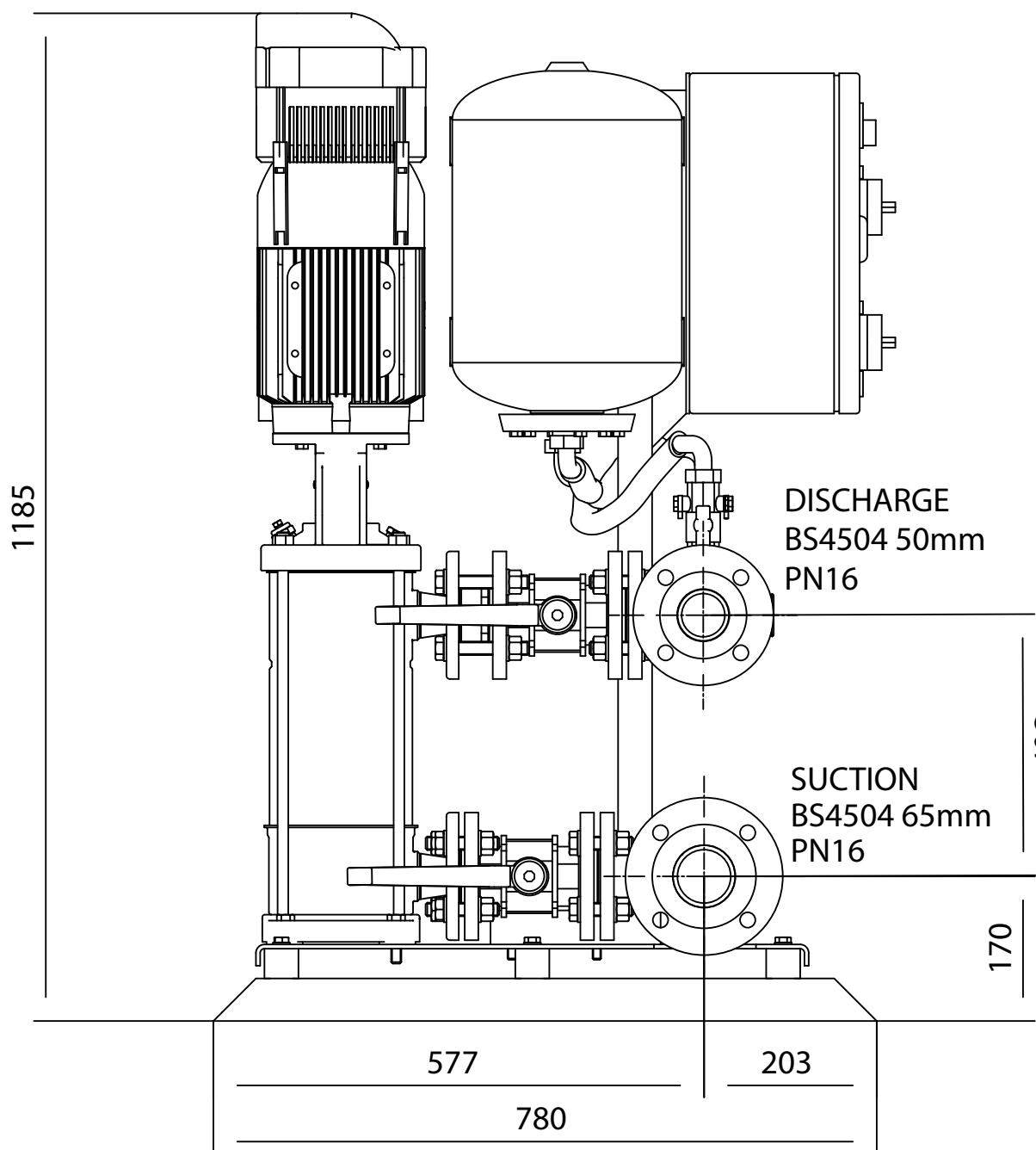
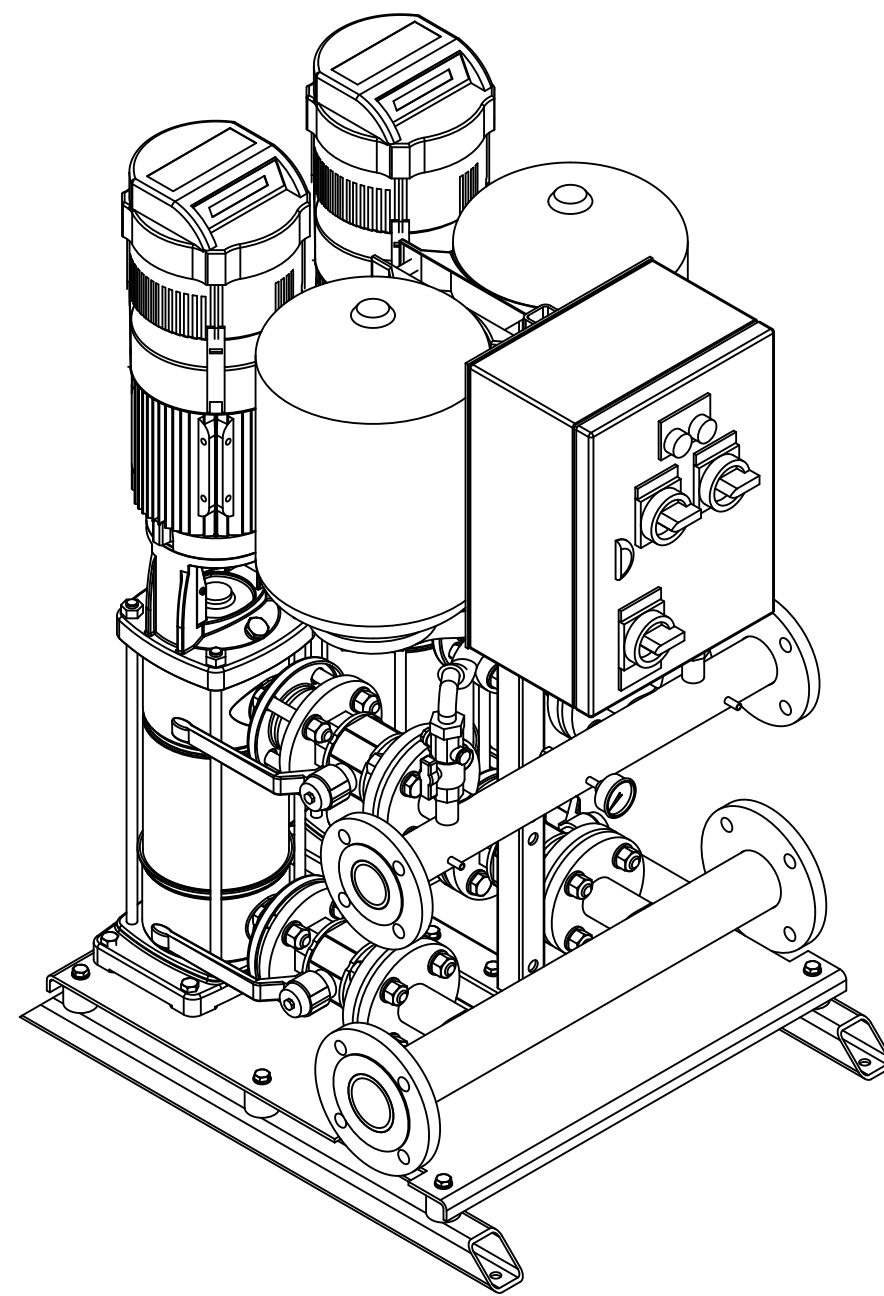

	NAME	DATE		
DRAWN	nigel	30/10/12		
CHECKED				
ENG APPR			TITLE	
MGR APPR				
UNLESS OTHERWISE SPECIFIED DIMENSIONS ARE IN MILLIMETERS ANGLES $\pm X.X^\circ$ 2 PL $\pm X.XX$ 3 PL $\pm X.XXX$			SIZE A3	DWG NO VR2-1009-LHT
			FILE NAME: VR2-1009-LHT.dft	REV
			SCALE:	WEIGHT:
			SHEET 1 OF 1	