

REVISION HISTORY			
REV	DESCRIPTION	DATE	APPROVED

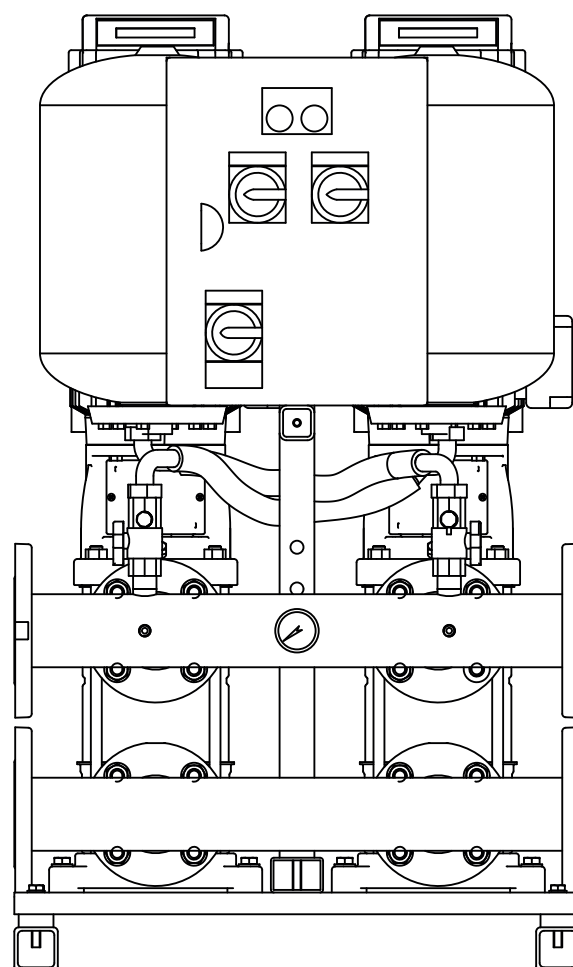
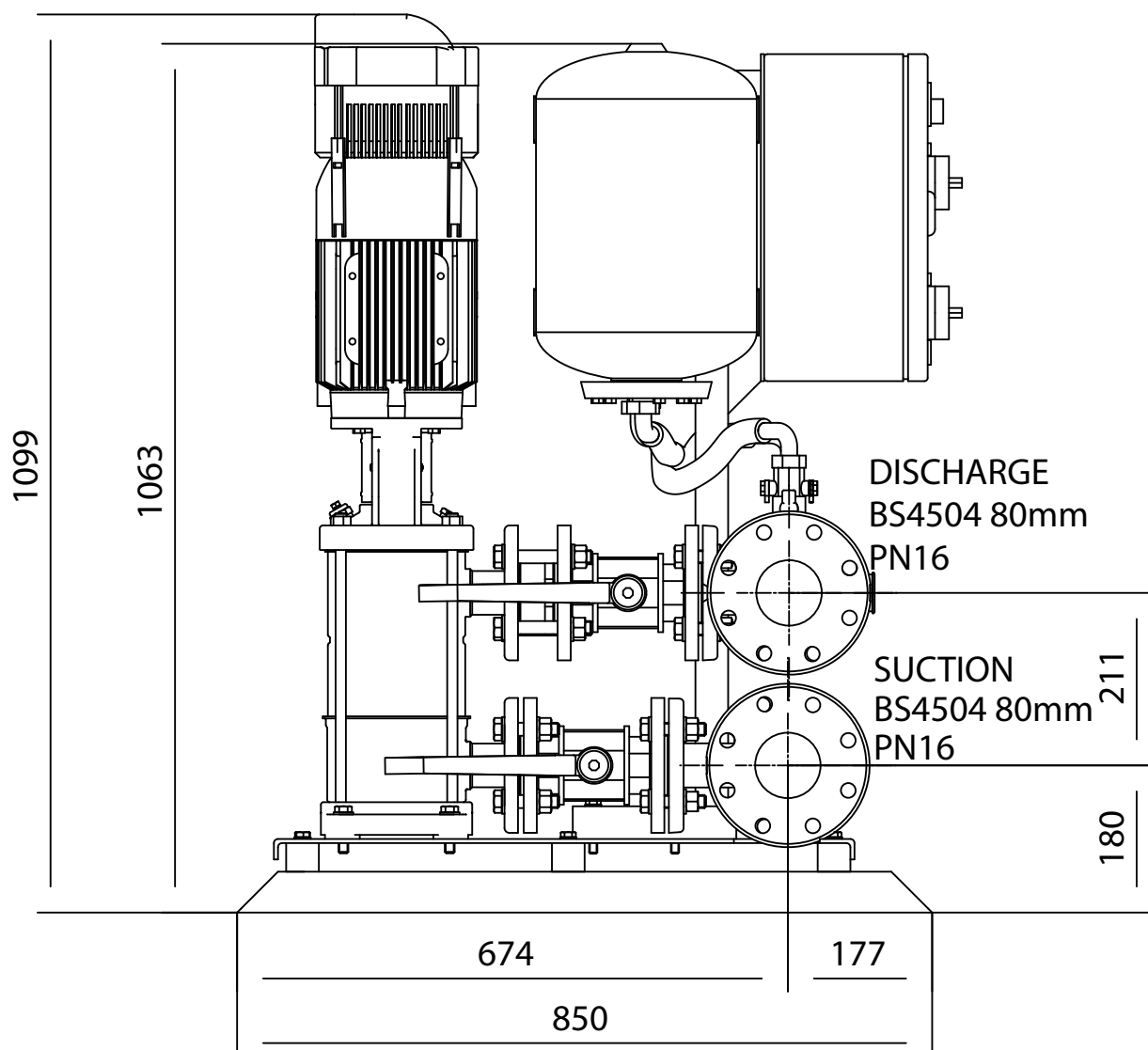
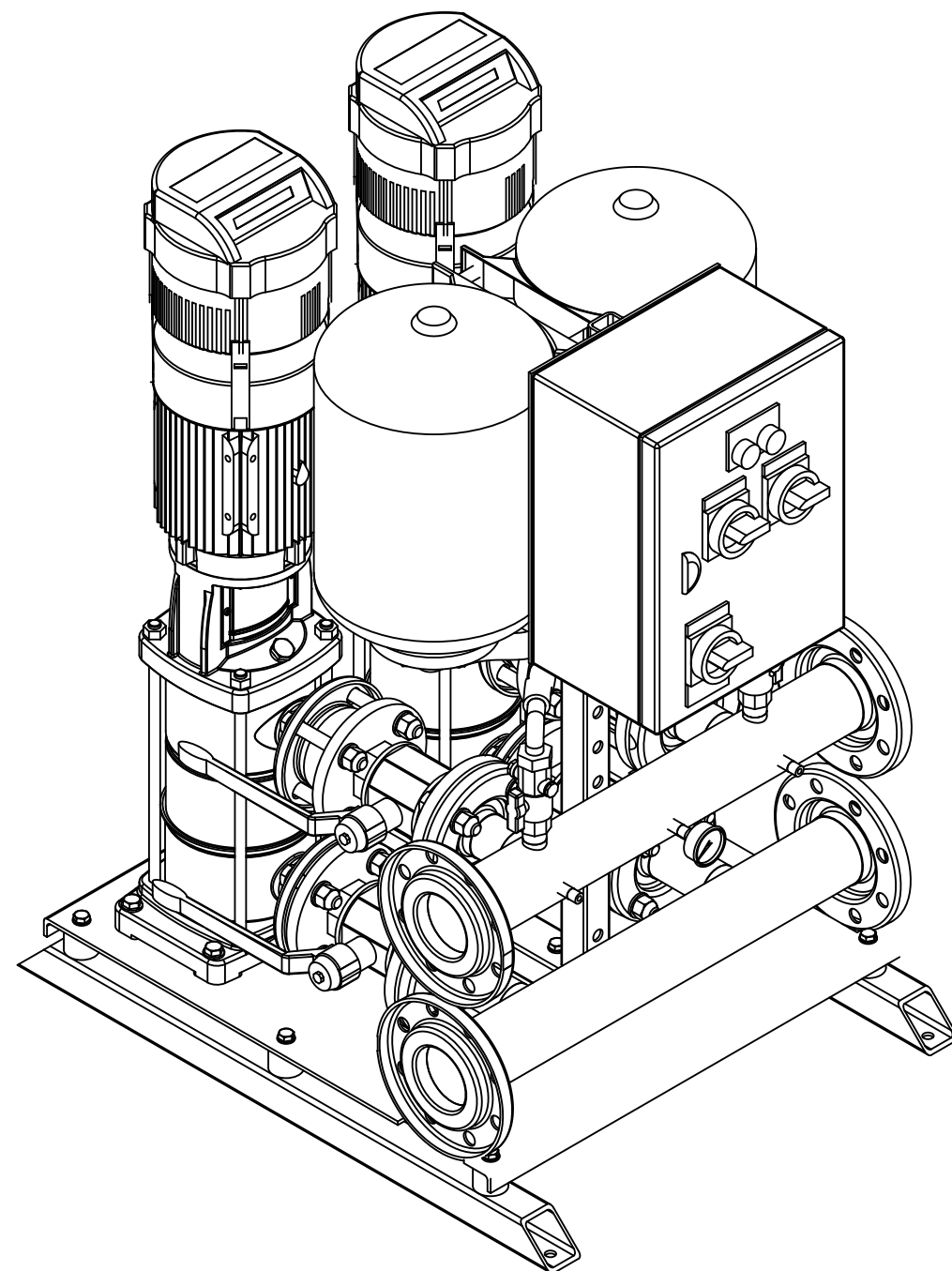
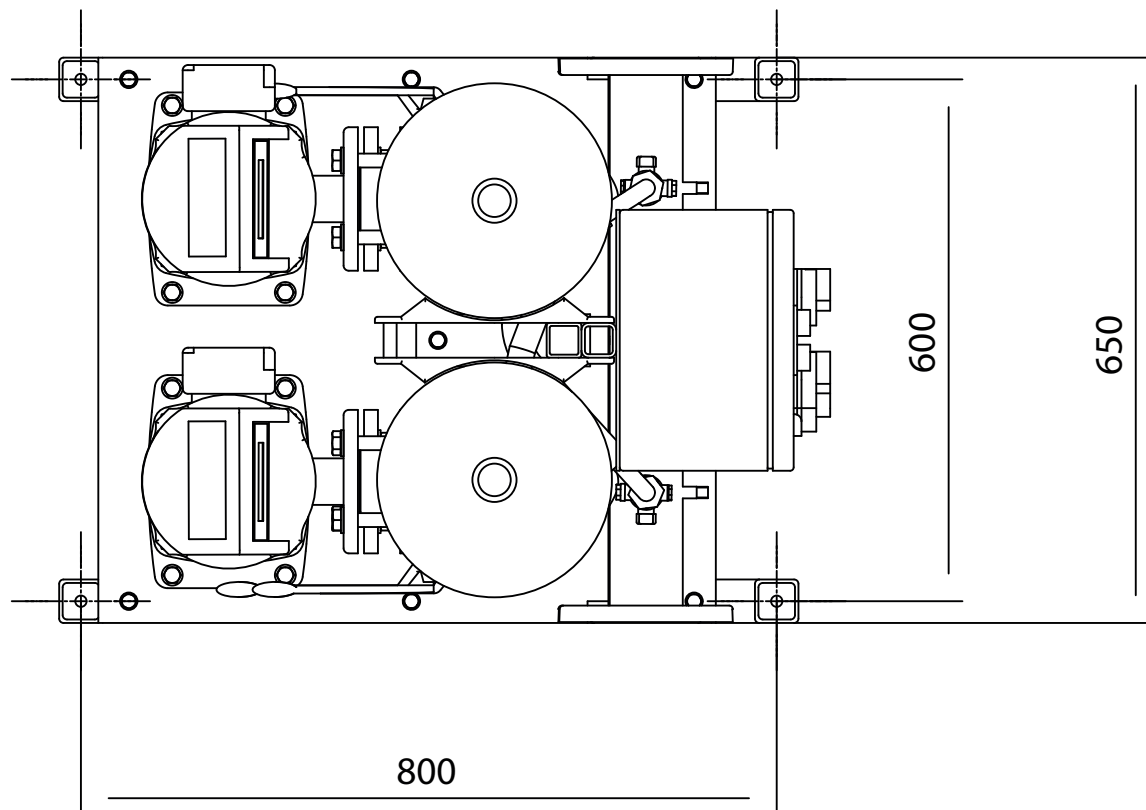

	NAME	DATE			
DRAWN	nigel	09/11/11			
CHECKED					
ENG APPR					
MGR APPR					
UNLESS OTHERWISE SPECIFIED DIMENSIONS ARE IN MILLIMETERS ANGLES $\pm X.X^\circ$ 2 PL $\pm X.XX$ 3 PL $\pm X.XXX$			SIZE A3	DWG NO VR2-1504-LHT	REV
			FILE NAME: VR2-1504-LHT.dft	SCALE:	WEIGHT:
					SHEET 1 OF 1