

REVISION HISTORY			
REV	DESCRIPTION	DATE	APPROVED

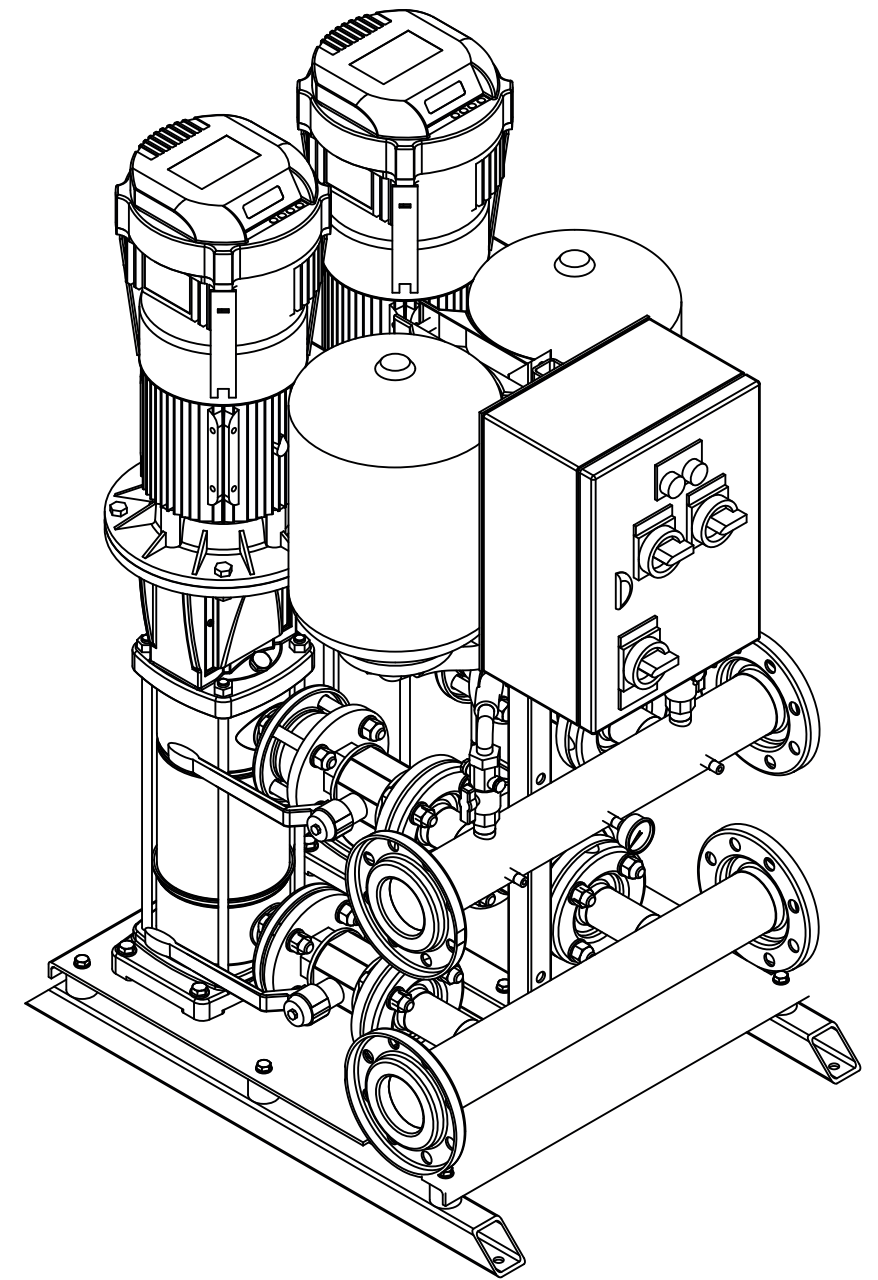

	NAME	DATE		
DRAWN	nigel	09/11/11		
CHECKED				
ENG APPR			TITLE	
MGR APPR				
UNLESS OTHERWISE SPECIFIED		SIZE	DWG NO	REV
DIMENSIONS ARE IN MILLIMETERS		A3	VR2-1506-LHT	
ANGLES $\pm X.X^\circ$		FILE NAME: VR2-1506-LHT.dft		
2 PL $\pm X.XX$ 3 PL $\pm X.XXX$		SCALE:	WEIGHT:	SHEET 1 OF 1