

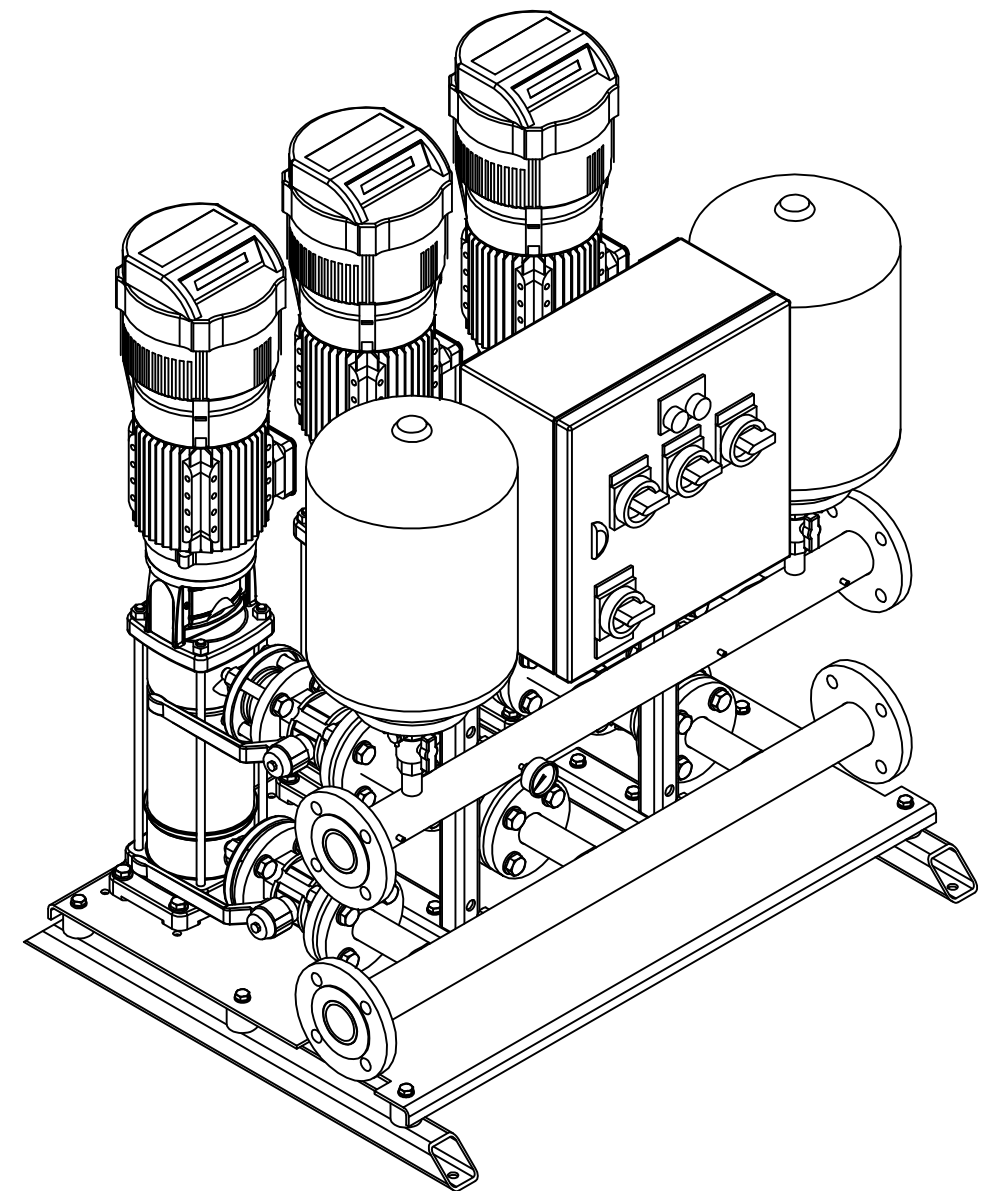

REVISION HISTORY			
REV	DESCRIPTION	DATE	APPROVED



	NAME	DATE			
DRAWN	nigel	09/11/11			
CHECKED					
ENG APPR					
MGR APPR			TITLE		
UNLESS OTHERWISE SPECIFIED DIMENSIONS ARE IN MILLIMETERS ANGLES ±X.X° 2 PL ±X.XX 3 PL ±X.XXX			SIZE	DWG NO	REV
			A3	VR3-0511-LHM	
			FILE NAME:	VR3-0511-LHM.dft	
			SCALE:	WEIGHT:	SHEET 1 OF 1