

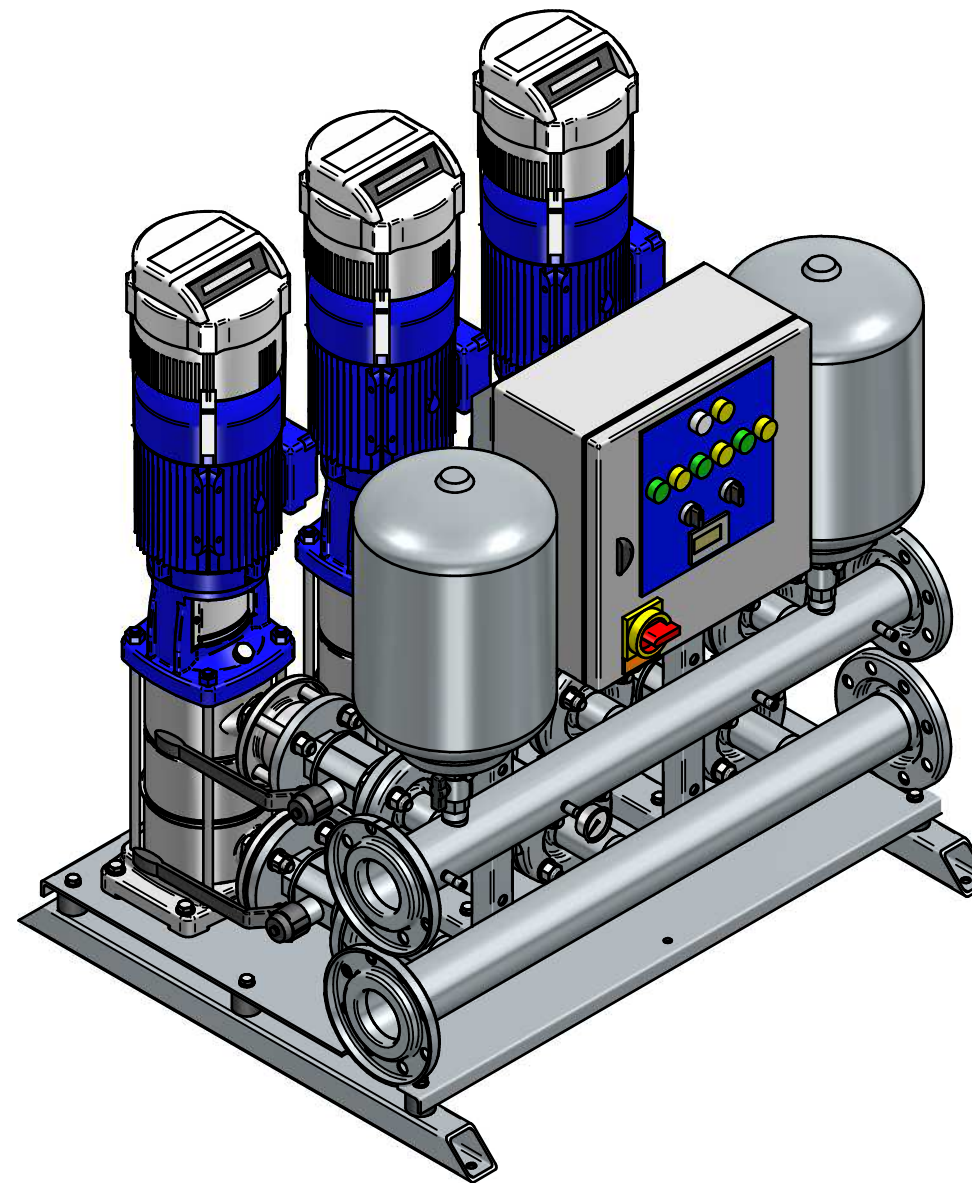

REVISION HISTORY			
REV	DESCRIPTION	DATE	APPROVED



DRAWN	NAME nigel	DATE 06/02/13			
CHECKED					
ENG APPR					
MGR APPR			TITLE		
UNLESS OTHERWISE SPECIFIED DIMENSIONS ARE IN MILLIMETERS ANGLES ±X.X° 2 PL ±X.XX 3 PL ±X.XXX			SIZE A3	DWG NO VR3-1502-LHT	REV
			FILE NAME: VR3-1502-LHT.dft		
SCALE:		WEIGHT:	SHEET 1 OF 1		