

REVISION HISTORY			
REV	DESCRIPTION	DATE	APPROVED

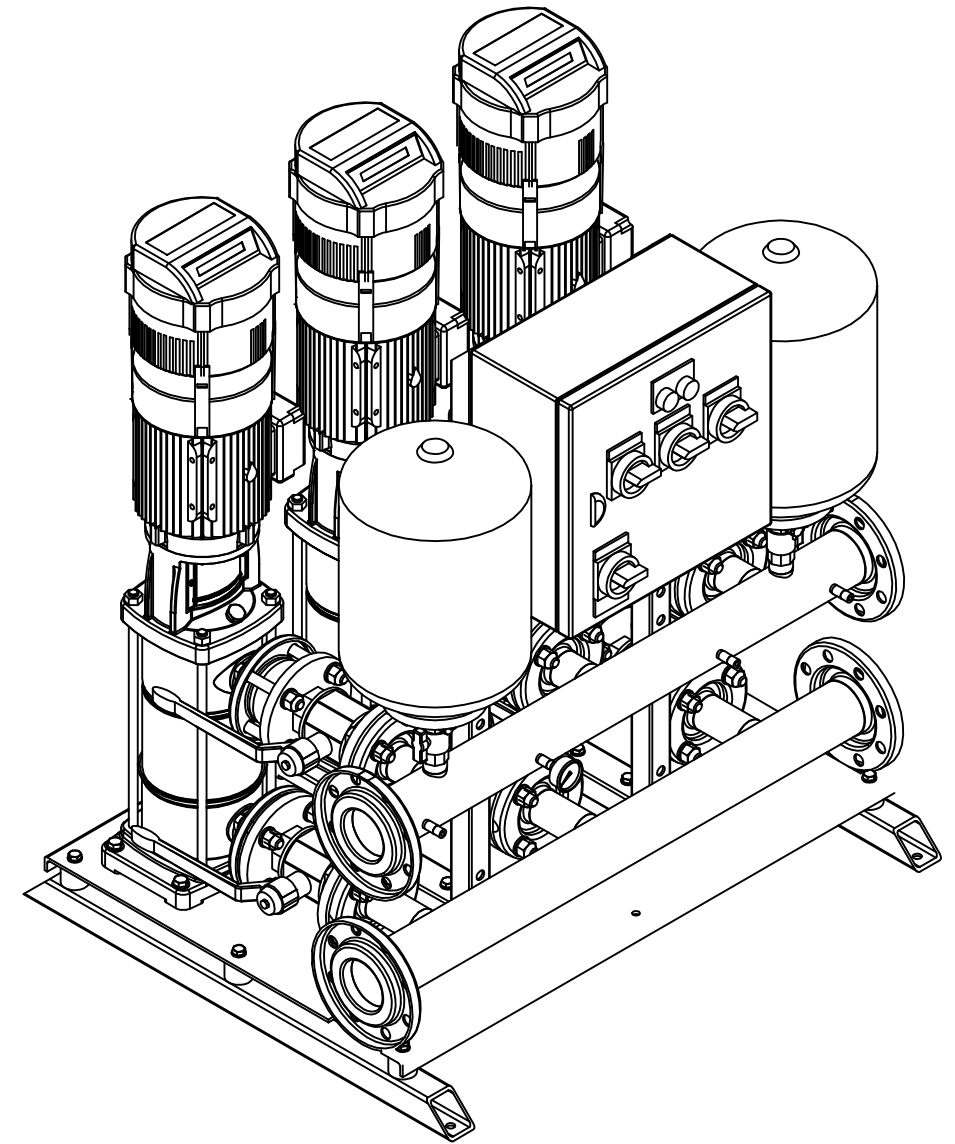

	NAME	DATE				
DRAWN	nigel	11/11/11				
CHECKED						
ENG APPR						
MGR APPR			TITLE	SIZE	DWG NO	REV
UNLESS OTHERWISE SPECIFIED DIMENSIONS ARE IN MILLIMETERS ANGLES ±X.X° 2 PL ±X.XX 3 PL ±X.XXX				A3	VR3-2205-LHT	
			FILE NAME: VR3-2205-LHT.dft			
			SCALE:	WEIGHT:	SHEET 1 OF 1	