

VT3-20-055

Product Description

The DutyPoint VT is a cost effective commercial and industrial booster set, designed to be both affordable to purchase and simple to maintain over its lifespan.

The VT features high specification AISI 304 stainless steel vertical multistage pumps with oversized bearings to reduce wear and decrease vibrations from moving parts.

The system is designed to be straightforward to maintain, both electrically and mechanically, for maintenance or replacement while the booster set is operating.

WRAS	<ul style="list-style-type: none"> ● WRAS Approved, All products in the new VT Cold Water Pressure Booster range are fully WRAS approved.
Control Panel	<ul style="list-style-type: none"> ● Variable speed pumps ● Hand / Off / Auto Settings for emergency situations. ● Volt free contacts for : <ul style="list-style-type: none"> - Common fault - Low water level - High water level
Protection	<ul style="list-style-type: none"> ● Anti-Seize technology which rotates all pumps during low or zero usage and prevents the pumps from seizing up. ● Burst pipe protection which constantly monitors the system for signs of major leakage. If detected, an alarm is activated followed by full system deactivation if the required duty is still not met. ● Cyclic duty changeover which ensures even wear across all pumps in the system. ● Low Water Protection technology which deactivates the pumps if there is no water in the break tank, protecting against dry running. ● HiRISE technology which protects the building's pipework by ensuring the pumps start slowly during the initial fill process or following power failure to prevent potentially dangerous surges and consequent damage to the riser.



Specification

Suction connection	DN100
Delivery connection	DN100
Max operating flow (per pump)	9.4 l/s
Max operating pressure	6.0 bar
Closed valve pressure	6.7 bar
Maximum system pressure rating	10 bar
Speed	Variable
IP rating	IP55
Motor power	5.5 kW
Weight	TBA kg
Pressure vessels N° x [Litres]	2 x [24]
Maximum operating temperature	40 °C

Set Performance

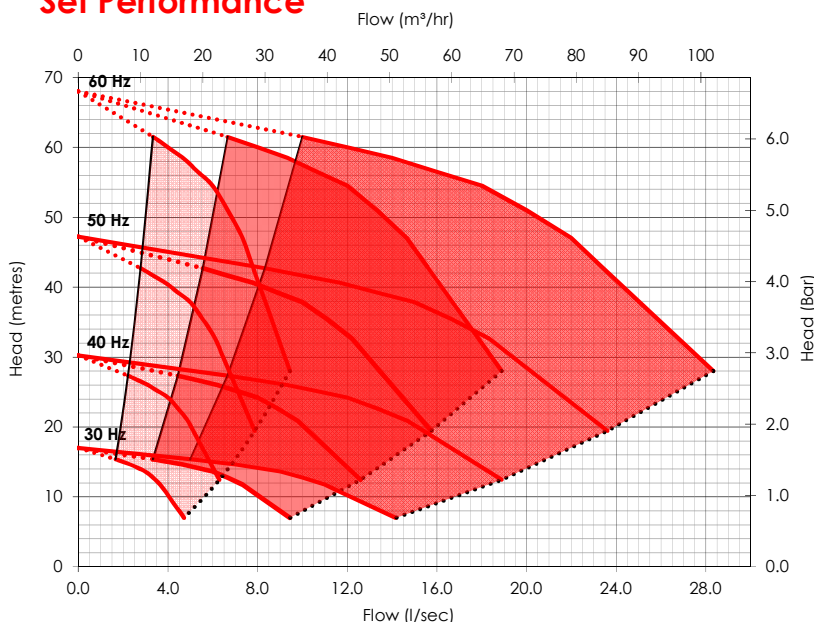

DUTYPOINT [®]

www.dutypoint.com

Electrical Data

Single Phase 1 ϕ Variant	
Operating speed range	30 - 60Hz
Per pump Current @ Full Load	18.2 A
Total Current @ Full Load	54.6 A

Three Phase 3 ϕ Variant	
Operating speed range	30 - 60Hz
Per pump Current @ Full Load	10.5 A
Total Current @ Full Load	31.5 A

VT model Codes

VT3-20-055T

Number of pumps

Nominal flow (m³/h)

Motor kW per pump

Power supply

Technical Drawing

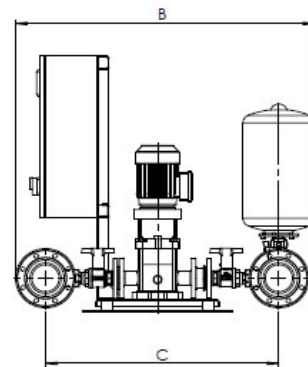
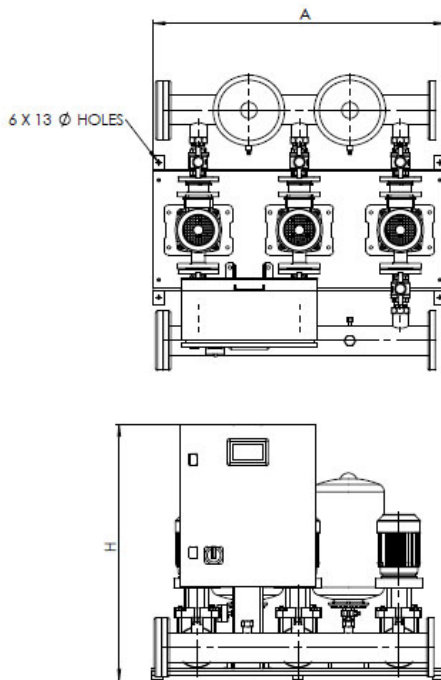

Drawing dimensions

Dimension A	1200
Dimension B	1190
Dimension C	948
Dimension H	1255