

4X TRANSPORTATION BRACKETS
 OPTIONAL BRACKET FOR WALL MOUNT

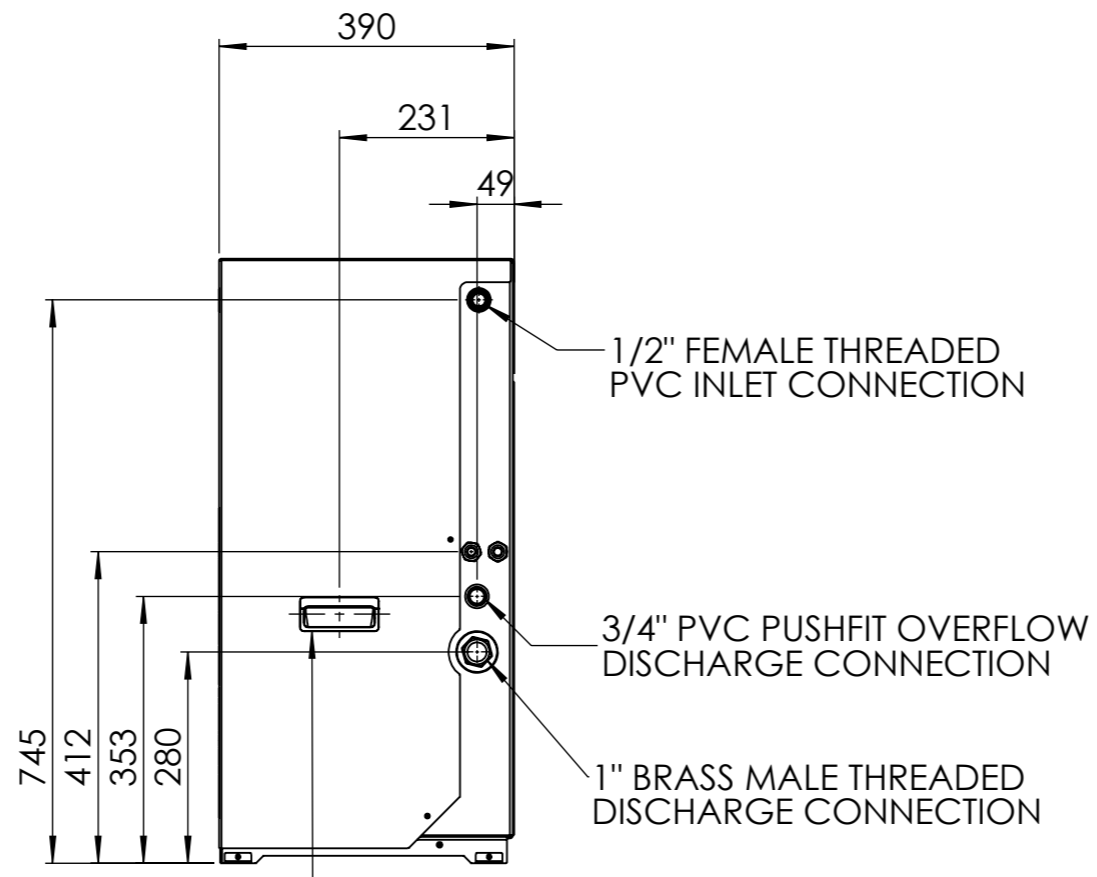

HANDLE FOR REMOVABLE COVER ON BOTH SIDES

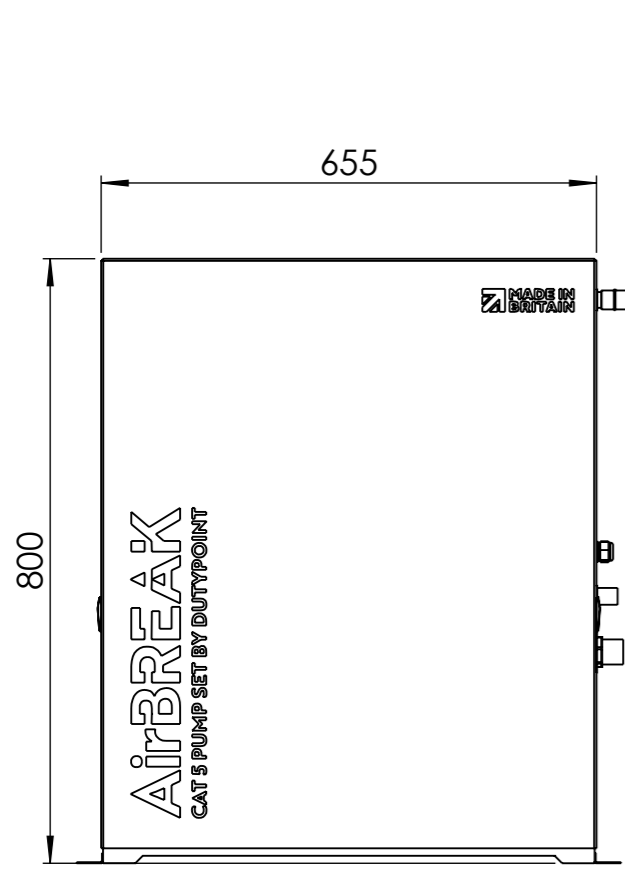
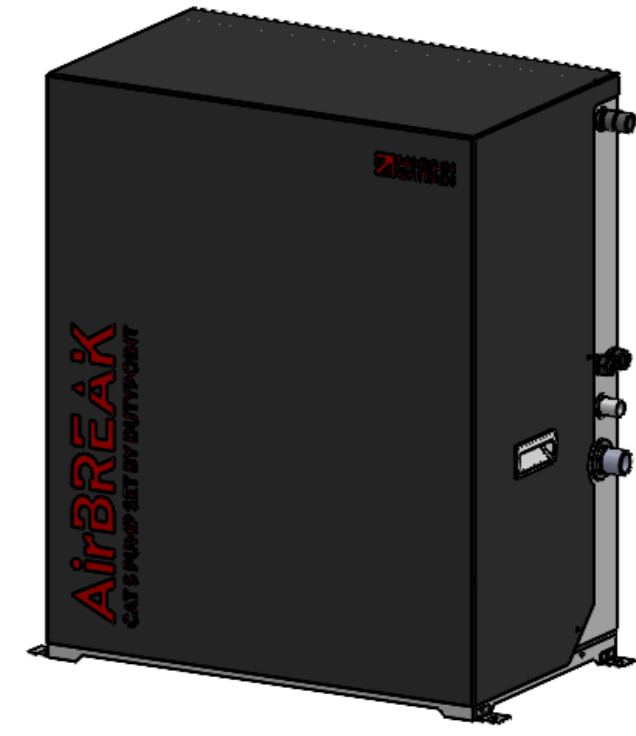
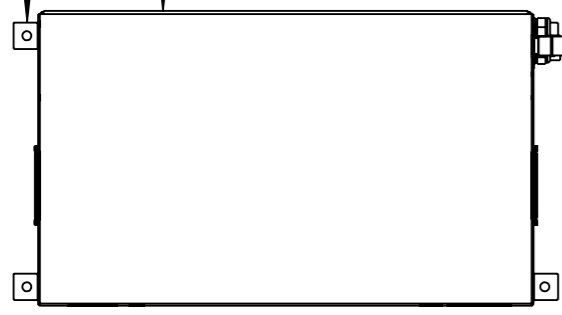
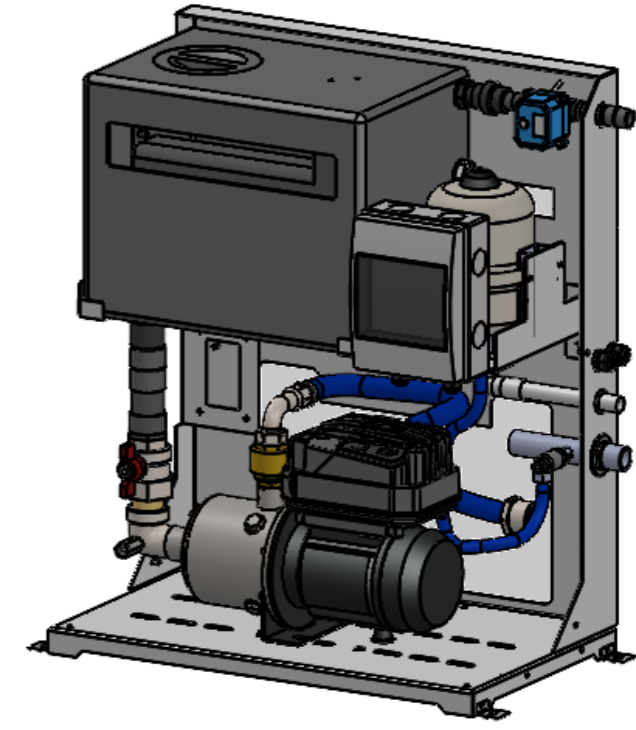

DUTYPOINT SETTING THE BAR

SHEPHERD ROAD, GLOUCESTER GL2 5EL
 (T): 01452 300 110

PROPRIETARY & CONFIDENTIAL
 DO NOT SCALE THIS DRAWING
 IF IN DOUBT

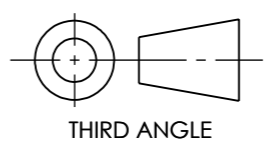

DRAWING NO:	10-005690-000	REV:	01.00
BIM NO:	XXX-XXX-XX-XX-XX-X-XX_XX_XX-XXXX-XX-XXX		
DESCRIPTION:	AIRBREAK VC1 - 05 - 011 M		
PROJECT NAME:			
MODEL NO.	AIRBREAK VC1 - 05 - 011 M		
SERIAL NO.		SHEET NO.	1 OF 1
PROJECT NO.		SCALE:	1:10
DRAWN BY:		23/01/2024	SHEET SIZE: A3
APPROVED BY:			WEIGHT KG: