

VRX2-22-040T

Product Description

The Dutypoint VRX is a premium, ultra high efficiency and space saving booster set for commercial and industrial applications.

The VRX features high efficiency IE5 motors and class leading motor mounted variable speed drives with large colour LCD displays and intuitive user HMI.

The system is designed to be straightforward to maintain, both electrically and mechanically, for maintenance or pump replacement while the booster set is operating.



WRAS	<ul style="list-style-type: none"> Water regulations approval pending
Control Panel	<ul style="list-style-type: none"> Variable speed pumps IE52 high system efficiency Volt free contacts for common fault and low water level IIOT Ready
Protection	<ul style="list-style-type: none"> Anti-Seize technology which rotates all pumps during low or zero usage and prevents the pumps from seizing up. Burst pipe protection which constantly monitors the system for signs of major leakage. If detected, an alarm is activated followed by full system deactivation if the required duty is still not met. Cyclic duty changeover which ensures even wear across all pumps in the system. Low Water Protection technology which deactivates the pumps if there is no water in the break tank, protecting against dry running. HiRISE technology which protects the building's pipework by ensuring the pumps start slowly during the initial fill process or following power failure to prevent potentially dangerous surges and consequent damage to the riser.

Set Performance

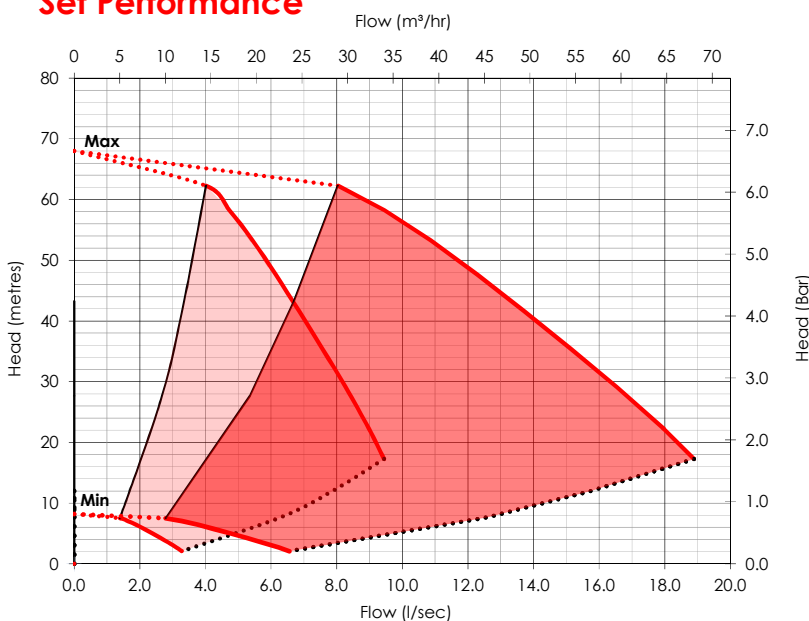

Specification

Suction connection	DN80
Delivery connection	DN80
Max operating flow (per pump)	9.4 l/s
Max operating pressure	6.4 bar
Closed valve pressure	6.7 bar
Maximum system pressure rating	10 bar
Speed	Variable
IP rating	IP55
Motor power	4 kW
Weight	230 kg
Pressure vessels N° x [Litres]	1 x [8L]
Maximum operating temperature	23 °C

DUTYPOINT 
www.dutypoint.com

Electrical Data

Three Phase 3 ϕ Variant	
Operating speed range	1250 - 3600 RPM
Per pump Current @ Full Load	7.7 A
Total Current @ Full Load	15.4 A

VRX model Codes

VRX2-05-030T

Number of pumps	05
Nominal flow (m ³ /h)	30
Motor kW per pump	3
Power supply	T

Technical Drawing

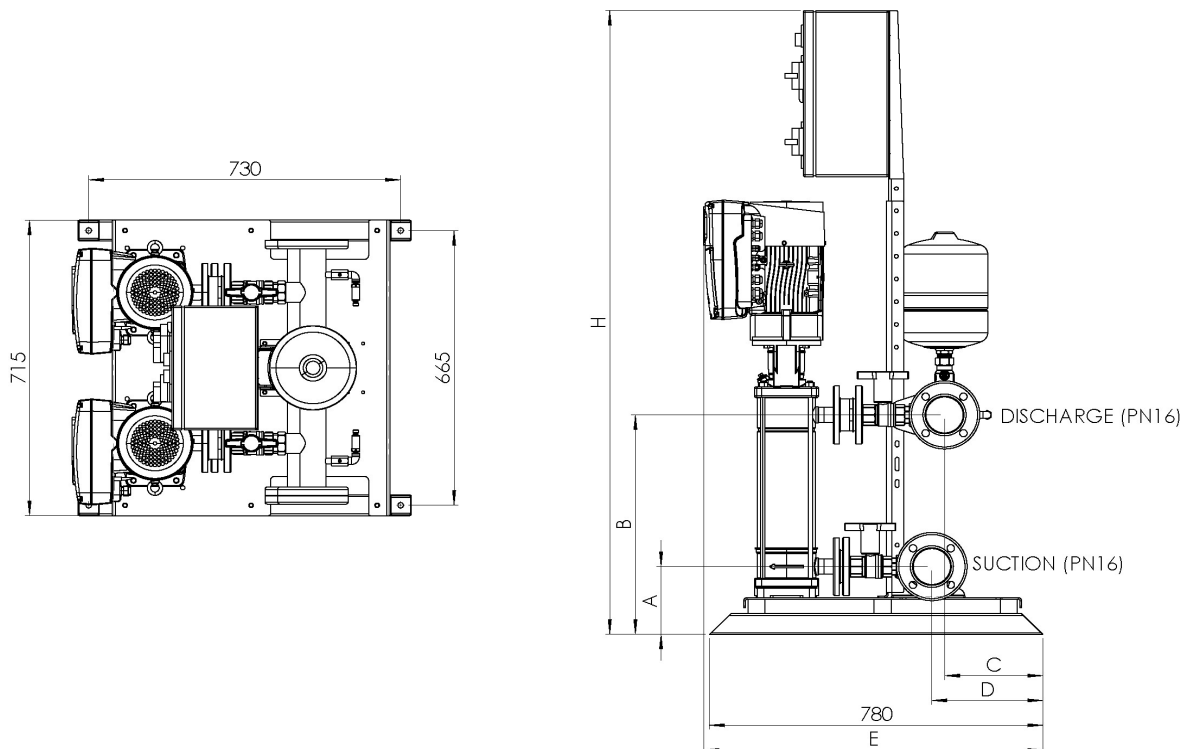

Drawing dimensions

Dimension A	179
Dimension B	438
Dimension C	128

Dimension D	170
Dimension E	794
Dimension H	1455